



DESIGN COLLECTION



# SCEGLI LA TUA CABINA

## CHOOSE YOUR ELEVATOR CABIN

**01. ESSENTIAL** \_\_\_\_\_ pag. 04  
*L'ascensore minimal / The minimal elevator*

**02. CLASSIC** \_\_\_\_\_ pag. 08  
*La semplicità nella scelta degli interni di cabina / Simplicity in the choice of car interiors*

**03. COMFORT** \_\_\_\_\_ pag. 14  
*L'ascensore sofisticato / The sophisticated elevator*

**04. UNIQUE** \_\_\_\_\_ pag. 21  
*La soluzione sempre perfetta, disegnata per te / Always the perfect solution, designed for you*

**PORTE - DOORS** \_\_\_\_\_ pag. 36  
*Un look impeccabile in ogni dettaglio / An impeccably detailed look*

**DISPLAY - DISPLAY** \_\_\_\_\_ pag. 40  
*Infiniti modi di personalizzare i tuoi display / You can always customize your display*

**ACCESSORI - ACCESSORIES** \_\_\_\_\_ pag. 42

**DATI PER LA PROGETTAZIONE - TECHNICAL DATA SHEET** \_\_\_\_\_ pag. 44





GOOD  
DESIGN

## Un premio all'alto Design Italiano

**La Savelli Ascensori  
vince il Good Design Award grazie  
all'innovativo ascensore Over View.**

La Savelli Ascensori è stata premiata come  
azienda più innovativa insieme alle più  
importanti multinazionali al mondo.

## An award for Italian Design

***Savelli Ascensori wins  
the Good Design Award (Chicago) thanks to  
the innovative OverView elevator.***

*Savelli Ascensori has been awarded the most  
innovative company together with the most  
famous multinationals of the world.*

# 01

---

## **ESSENTIAL**

L'ascensore minimal  
*The minimal elevator*

La collezione Essential offre uno stile lineare nei rivestimenti e negli accessori di cabina e di piano.

*The Essential collection offers a linear style for coverings and accessories of cars and floors.*

## ESSENTIAL

CARATTERISTICHE CABINA  
CAR FEATURES

Pavimento  
Floor

Linoleum P7 Grigio  
P7 Grey Linoleum

Pareti  
Walls

Lamiera plastificata R2 Bianco  
R2 White plastic-coated steel sheet

Pulsantiera  
Button panel

Line - lamiera plastificata R2 Bianco  
Line - R2 White plastic-coated steel sheet

Corrimano  
Handrail

Orbita - acciaio cromato fissato su parete the wall panel  
Luce - chrome-plated handrail, fixed to the wall panel

Sistema di illuminazione  
Lighting system

Puro - faretti a LED  
Puro - LED spots





RIVESTIMENTI PARETI / WALL FINISHES

LAMIERA PLASTIFICATA / PLASTIC COATED STEEL SHEET



R1 Grigio  
Grey

R2 Bianco  
White

R3 Nero  
Black

R4 Rosso  
Red

R5 Verde  
Green

R6 Verde  
chiaro  
Light green

R7 Beige  
Beige



R11 Argento  
Silver

S9 Grigio  
metallizzato  
Glossy grey

S25 Bianco  
Spatolato  
Spatular  
white

S26 Tessuto  
Fabric

PAVIMENTI / FLOORS

LINOLEUM / LINOLEUM



P2 Sabbia  
marmorizzato  
Marbled sand

P4 Nero  
marmorizzato  
Marbled  
black

P7 Grigio  
Grey

P11 Resina  
Grigia  
Resin Grey

PAVIMENTO VINILICO / VINYL FLOOR

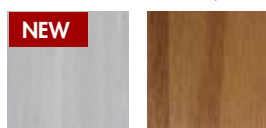

P13 Perla  
Pearl

P14 Legno  
Wood

**NOTA:** su richiesta è possibile predisporre il fondo per qualsiasi tipo di pavimento fornito dal cliente.  
On request, it is possible to arrange the cabin bottom for any type of floor provided by the customer.

PULSANTIERE / BUTTON PANEL

PULSANTIERA DI CABINA  
CAR BUTTON PANEL



**LINE**  
Montaggio a  
filo, disponibile  
negli stessi  
materiali dei  
rivestimenti delle  
pareti  
Flush mounting,  
same wall  
materials  
available

PULSANTIERA DI PIANO  
FLOOR BUTTON PANEL



**FLORENCE**  
Acciaio inox,  
1 pulsante  
Stainless steel,  
1 button



**MINIMAL**  
Acciaio inox,  
1 pulsante  
Stainless steel,  
1 button



## ESSENTIAL CHIC

CARATTERISTICHE CABINA  
CAR FEATURES

Pavimento <i>Floor</i>	Linoleum P2 Sabbia marmorizzato <i>P2 Marbled sand Linoleum</i>
Pareti <i>Walls</i>	Lamiera plastificata R2 Bianco <i>R2 White plastic-coated steel sheet</i>
Pulsantiera <i>Button panel</i>	Line - lamiera plastificata R2 Bianco <i>Line - R2 White plastic-coated steel sheet</i>
Corrimano <i>Handrail</i>	Orbita - cromato fissato su parete <i>Orbita - chrome-plated, fixed to the wall panel</i>
Sistema di illuminazione <i>Lighting system</i>	Puro - faretti a LED <i>Puro - LED Spots</i>
Specchio <i>Mirror</i>	Sfumatura - larghezza parziale, altezza totale <i>Sfumatura - total height, partial width</i>

SISTEMA DI ILLUMINAZIONE / LIGHTING SYSTEM



**PURO**

CIELINO: lamiera plastificata  
bianca  
ILLUMINAZIONE: faretti a LED  
CEILING: white plastic coated  
steel sheet  
LIGHTING: LED Spots

SPECCHI\*/MIRRORS\*

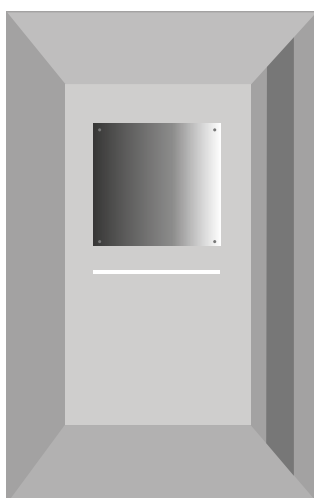

**VELO\***

Specchio fissato su parete  
Mirror fixed to the wall panel

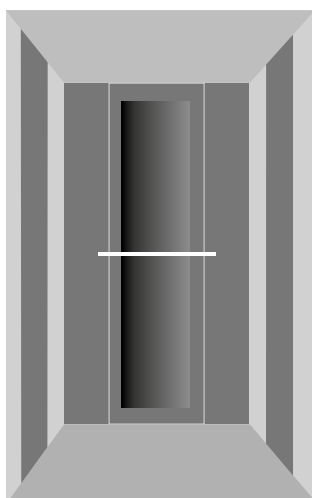

**SFUMATURA\***

Larghezza parziale, altezza totale  
Partial width, total height

CORRIMANO / HANDRAIL

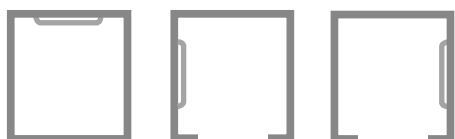

**ORBITA**

Corrimano in acciaio cromato  
fissato su parete  
Chrome-plated handrail, fixed to the  
wall panel

# 02

---

## **CLASSIC**

La semplicità nella scelta degli interni di cabina  
*Simplicity in the choice of car interiors*

La collezione Classic, offre soluzioni classiche e funzionali pensate per farsi notare e adattarsi all'ambiente circostante.

Savelli Ascensori propone una gamma di materiali accessibili per allestire armoniosamente il vostro ascensore.

*The Classic collection offers classical and functional solutions created to be noticed and to blend with the surrounding environment.*

*Savelli Ascensori proposes a range of materials to furnish your elevator harmoniously.*

## CLASSIC

CARATTERISTICHE CABINA  
CAR FEATURES

Pavimento  
Floor

Linoleum P4 Nero marmorizzato  
P4 Marbled black Linoleum

Pareti  
Walls

Lamiera plastificata R3 Nero  
R3 Black plastic-coated steel sheet

Pulsantiera e profili  
Button panel and profiles

Line - Lamiera plastificata R2 Bianco  
Line - R2 White plastic-coated steel sheet

Corrimano  
Handrail

Eclisse - inox cromato fissato su parete  
Eclisse - chrome-coated, built into the panel

Sistema di illuminazione  
Lighting system

Puro - faretti a LED  
Puro - LED Spots

Specchio  
Mirror

Luce - specchio a mezza parete  
Luce - half wall mirror



RIVESTIMENTI PARETI / WALL FINISHES

LAMIERA PLASTIFICATA / PLASTIC COATED STEEL SHEET

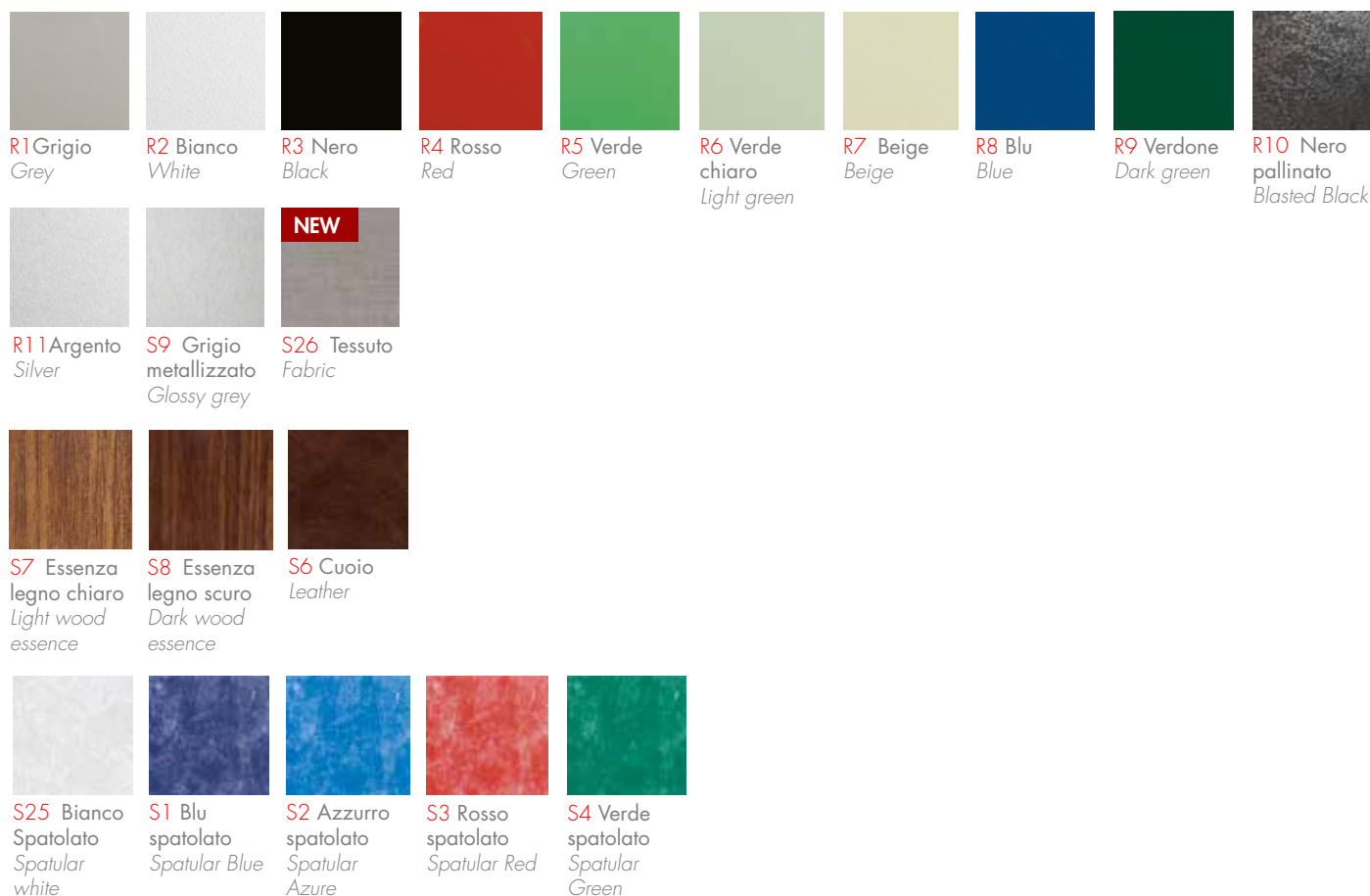

PAVIMENTI / FLOOR

LINOLEUM / LINOLEUM



GOMMA / RUBBER



P3 Gomma bolli nero Studded rubber black

PAVIMENTO VINILICO / VINYL FLOOR

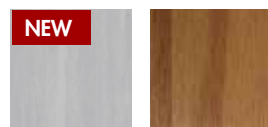

P13 Perla Pearl

P14 Legno Wood

## CLASSIC

CARATTERISTICHE CABINA  
CAR FEATURES

Pavimento <i>Floor</i>	Linoleum P11 Grigio marmorizzato <i>P11 Marbled Grey Linoleum</i>
Pareti <i>Walls</i>	Lamiera plastificata R2 Bianco <i>R2 White plastic-coated steel sheet</i>
Pulsantiera <i>Button panel</i>	Line - lamiera plastificata R2 Bianco <i>Line - R2 White plastic-coated steel sheet</i>
Corrimano <i>Handrail</i>	Eclisse - acciaio cromato incassato su parete <i>Eclisse - chrome-coated, built into the panel</i>
Sistema di illuminazione <i>Lighting system</i>	Trama* - strisce LED <i>Trama* - LED stripes</i>
Specchio <i>Mirror</i>	Luce - a mezza parete <i>Luce - half wall mirror</i>



SISTEMI DI ILLUMINAZIONE / LIGHTING SYSTEMS



**PURO**

CIELINO: lamiera plastificata bianca  
 ILLUMINAZIONE: faretto a LED  
 CEILING: white plastic coated steel sheet  
 LIGHTING: round LED Spots



**TRAMA\***

CIELINO: lamiera plastificata bianca  
 ILLUMINAZIONE: strisce LED  
 CEILING: white plastic coated steel sheet  
 LIGHTING: LED stripes

PULSANTIERE / BUTTON PANEL

PULSANTIERA DI CABINA  
 CAR BUTTON PANEL



**LINE**

Montaggio a filo, disponibile negli stessi materiali dei rivestimenti delle pareti  
 Flush mounting, same wall materials available

PULSANTIERA DI PIANO  
 FLOOR BUTTON PANEL



**MINIMAL**

Acciaio inox, 1 pulsante  
 Stainless steel, 1 button



**FLORENCE**

Acciaio inox, 1 pulsante  
 Stainless steel, 1 button

CORRIMANI/HANDRAILS

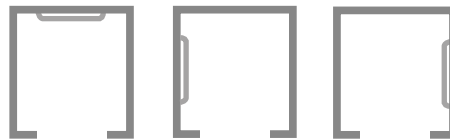

**ORBITA**

Corrimano in acciaio cromato fissato su parete  
 Chrome-coated handrail, fixed to the panel



**ECLISSE**

Corrimano acciaio cromato incassato su parete  
 Chrome-coated handrail, built into the panel

SPECCHI/MIRRORS

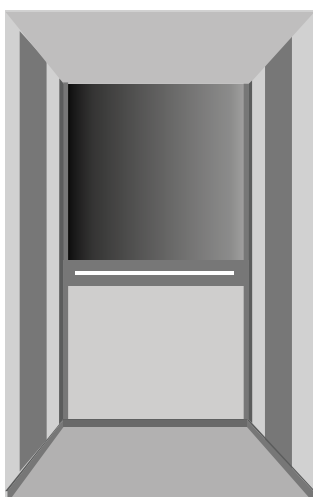

**LUCE**

Specchio a mezza parete  
 Half wall mirror

# 03

---

## COMFORT

L'ascensore sofisticato  
*The sophisticated elevator*

La collezione Comfort, offre interni flessibili, eleganti e sofisticati che si adattano perfettamente a qualsiasi ambiente. Soluzioni ricercate ed eleganti, creano un ambiente accattivante e armonioso al tempo stesso.

*The Comfort collection offers elegant and sophisticated interiors, which blend with any environment. Elegant and refined solutions create an harmonious and endearing space at the same time. This collection combines patterned coverings in stainless steel sheet, to obtain a balance between nature and technology.*



## COMFORT

CARATTERISTICHE CABINA  
CAR FEATURES

Pavimento  
Floor

Cemento G7  
G7 Cement

Pareti  
Walls

Acciaio scotch brite S15  
S15 Scotch brite stainless steel

Specchio  
Mirror

Riflesso - specchio a tutta altezza intelaiato  
Riflesso - full wall mirror with protection frame

Pulsantiera, Aerazione, profili  
Button panel, Ventilation, angle  
profiles

Line\* - acciaio inox BA lucido  
Line\* - glossy BA stainless steel

Sistema di illuminazione  
Lighting system

Segno - strisce LED  
Segno - LED stripes

## RIVESTIMENTI PARETI / WALL FINISHES

### LAMIERA PLASTIFICATA / PLASTIC COATED STEEL SHEET

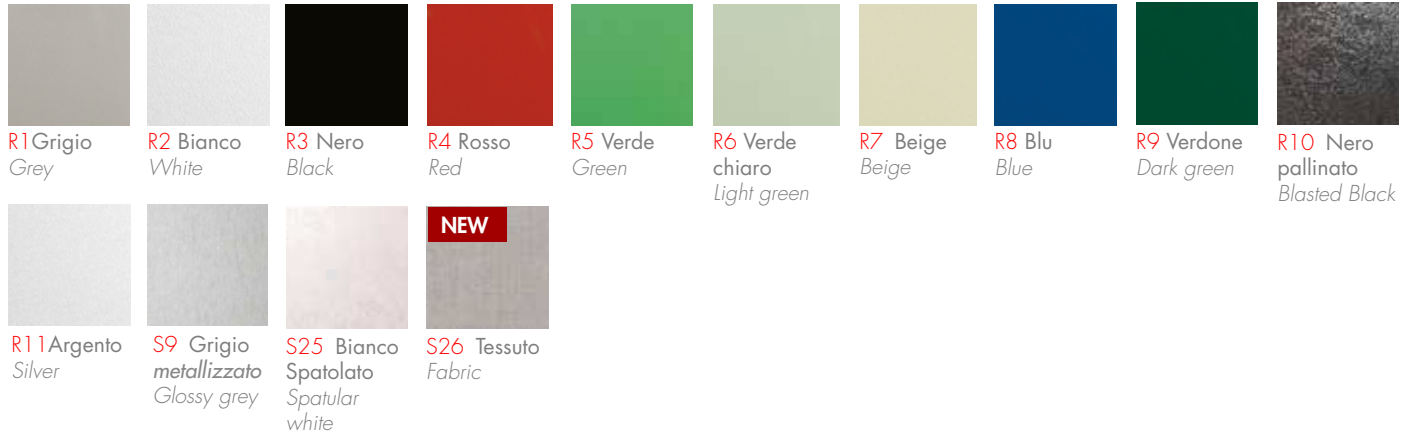

### ACCIAIO INOX - ALLUMINIO / STAINLESS STEEL - ALUMINUM

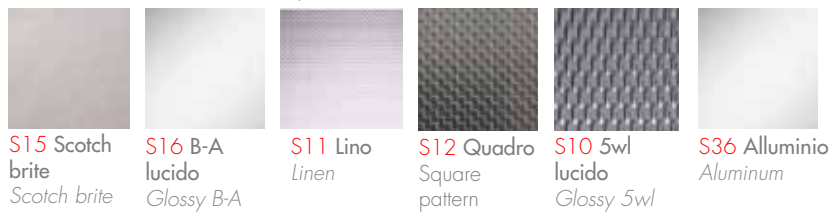

### LAMINATO / LAMINATED

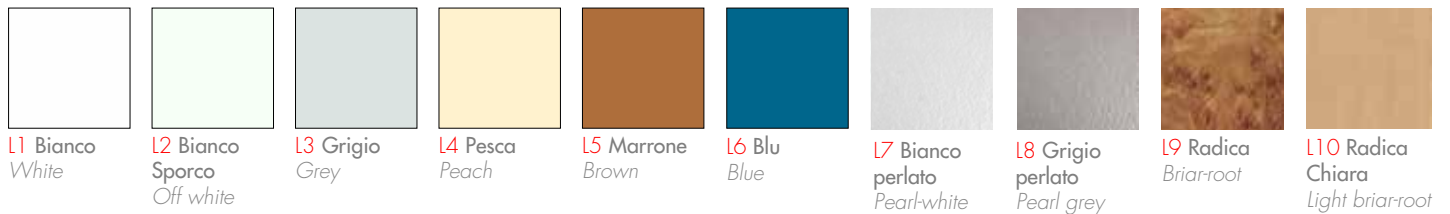

## PAVIMENTI / FLOORS

### PAVIMENTO VINILICO - EFFETTO LEGNO (Doga 178X1219mm) / VINYL FLOOR - WOOD ESSENCE (Slat 178X219mm)

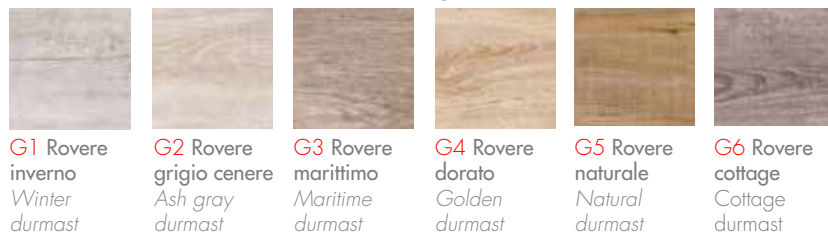

### PAVIMENTO VINILICO - EFFETTO TENDENCY (Piastra 305X610 mm) / VINYL FLOOR - TENDECY EFFECT (Slat 178X219 mm)



### ACCIAIO INOX / STAINLESS STEEL



## COMFORT

CARATTERISTICHE CABINA  
CAR FEATURES

Pavimento  
Floor

A cura del committente  
Provided by the client

Pareti  
Walls

Laminato bianco L1 con strisce cromate  
L1 white laminate with chrome stripes

Specchio  
Mirror

Luce - specchio a mezza parete  
Luce - half-wall mirror

Pulsantiera, Aerazione, profili  
Button panel, Ventilation, angle  
profiles

Line Colour - acciaio inox BA lucido  
Line Colour - glossy B-A stainless

Corrimano  
Handrail

Eclisse - inox cromato, incassato su parete  
Eclisse - chrome-coated handrail, built into the panel

Sistema di illuminazione  
Lighting system

Diffuso - modulo LED  
Diffuso - LED module

**BOTTONIERA DI CABINA / CAR BUTTON PANEL**



**LINE**  
 Montaggio a filo, display LCD, disponibile negli stessi materiali dei rivestimenti delle pareti  
*Flush mounting, LCD display same wall materials available*



**LINE COLOUR**  
 Montaggio a filo, display TFT, disponibile negli stessi materiali dei rivestimenti delle pareti  
*Flush mounting, TFT display, same wall materials available*



**LINE\***  
 Montaggio a filo, display TFT, strisce LED, disponibile negli stessi materiali dei rivestimenti delle pareti  
*Flush mounting, TFT display, same wall materials available*



**FLORENCE**  
 Pulsantiera di cabina in acciaio inox con display TFT  
*Stainless steel COP with TFT display*

**PULSANTIERA DI PIANO / FLOOR BUTTON PANEL**

**FLORENCE**

Finiture: acciaio inox scotch brite, lucido, mirror, oro\* e oro satinato\* (su richiesta altre finiture)  
*Finish: scotch brite, glossy, mirror stainless steel, gold\* and satin gold\* (other finishes on request)*



Acciaio inox,  
 1 pulsante + display  
*Stainless steel, 1 button + display*



Acciaio inox,  
 2 pulsanti  
*Stainless steel, 2 buttons*



Acciaio inox,  
 1 pulsante  
*Stainless steel, 1 button*

**MINIMAL**

Finiture: acciaio inox scotch brite, lucido, mirror, oro\* e oro satinato\* (su richiesta altre finiture)  
*Finish: scotch brite, glossy, mirror stainless steel, gold\* and satin gold\* (other finishes on request)*



Acciaio inox,  
 1 pulsante  
*Stainless steel, 1 button*

**BUGATTI**

Finiture: scotch brite, nero\*, madreperla\* e lucida\* (cromo e oro)  
*Finish: scotch brite stainless steel, black\*, Pearl\* and mirrored (chrome and gold)\**



Acciaio inox,  
 1 pulsante + display  
*Stainless steel, 1 button + display*



Acciaio inox,  
 2 pulsanti  
*Stainless steel, 2 buttons*



Acciaio inox,  
 1 pulsante  
*Stainless steel, 1 button*

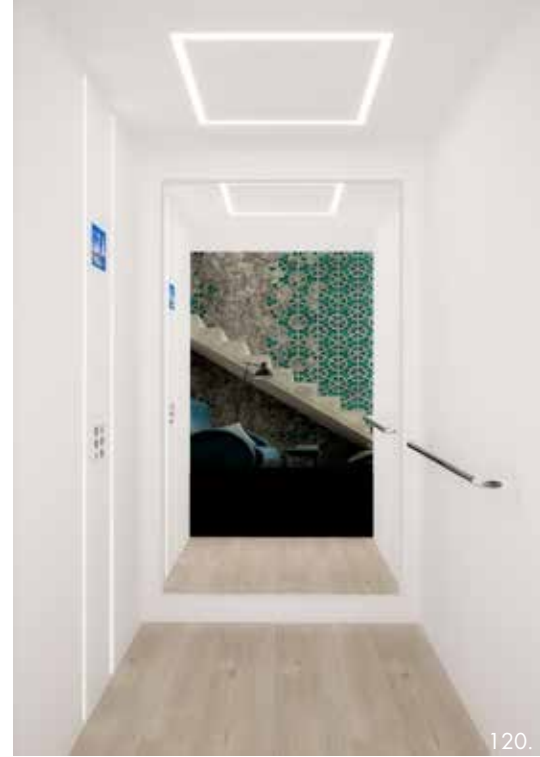

SISTEMI DI ILLUMINAZIONE / LIGHTING SYSTEMS



**PURO**  
 CIELINO: lamiera plastificata  
 bianca o acciaio inox  
 ILLUMINAZIONE: faretto a LED  
 CEILING: white plastic coated  
 steel sheet or stainless steel  
 LIGHTING: LED Spots



**TRAMA**  
 CIELINO: lamiera plastificata  
 bianca o acciaio inox  
 ILLUMINAZIONE: strisce LED  
 CEILING: white plastic coated  
 steel sheet or stainless steel  
 LIGHTING: LED stripes



**SEGNO**  
 CIELINO: lamiera plastificata  
 bianca o acciaio inox  
 ILLUMINAZIONE: strisce LED  
 CEILING: white plastic coated  
 steel sheet or stainless steel  
 LIGHTING: LED stripes



**RAGGIO**  
 CIELINO: lamiera plastificata  
 bianca o acciaio inox  
 ILLUMINAZIONE: modulo LED  
 CEILING: white plastic coated  
 steel sheet or stainless steel  
 LIGHTING: LED module

SPECCHI / MIRRORS

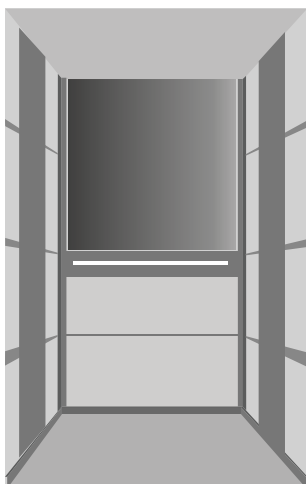

**LUCE**  
 Specchio a mezza parete  
 Half-wall Mirror

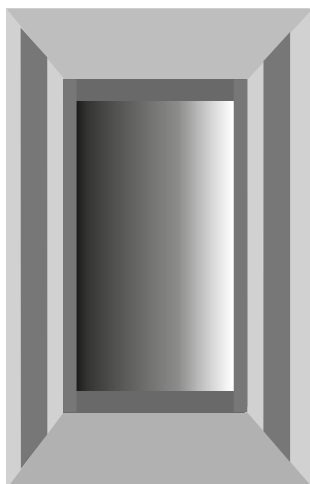

**RIFLESSO**  
 Specchio a tutta altezza con  
 cornice di protezione  
 Full-wall mirror with protection  
 frame

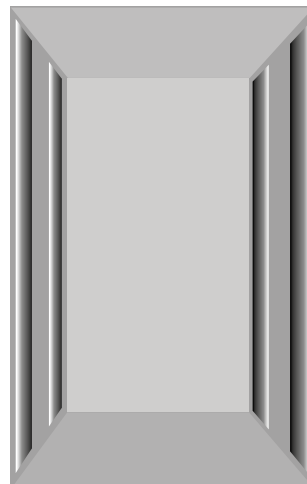

**PROIEZIONE**  
 Specchi laterali a tutta altezza  
 con cornici di protezione  
 Full-wall mirrors with protection  
 frames on walls side

CORRIMANI / HANDRAILS

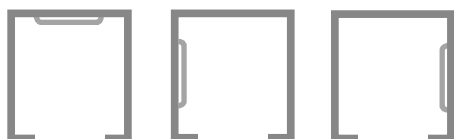

**ORBITA**  
 Corrimano cromato fissato  
 su parete  
 Chrome-coated handrail,  
 fixed to the panel



**ECLISSE**  
 Corrimano cromato  
 incassato su parete  
 Chrome-coated handrail,  
 built into the panel

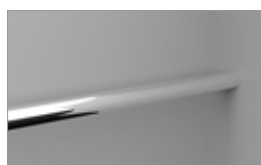

**AURORA**  
 Corrimano alluminio o  
 acciaio inox  
 Aluminum or stainless steel  
 handrail



# 04

---

## UNIQUE

La soluzione sempre perfetta disegnata da te, per te.  
*Always the perfect solution designed by you for you.*

La collezione Unique offre un design esclusivo e personalizzabile in grado di soddisfare qualsiasi richiesta del cliente, dalla scelta alla combinazione dei materiali e degli accessori. Un raffinato spazio polisensoriale, dove materiali pregiati e ricercate finiture offrono una coinvolgente esperienza tattile e visiva.

*The Unique collection offers an exclusive, tailored and classy design, able to satisfy any request of the client, from the choice to the combination of materials and accessories.*

*A sophisticated multi-sensory environment, where precious materials and refined finishes offer an engaging tactile and visual experience.*

30 Kg & Per.

- 2
- 1
- 0
- 9
- 8

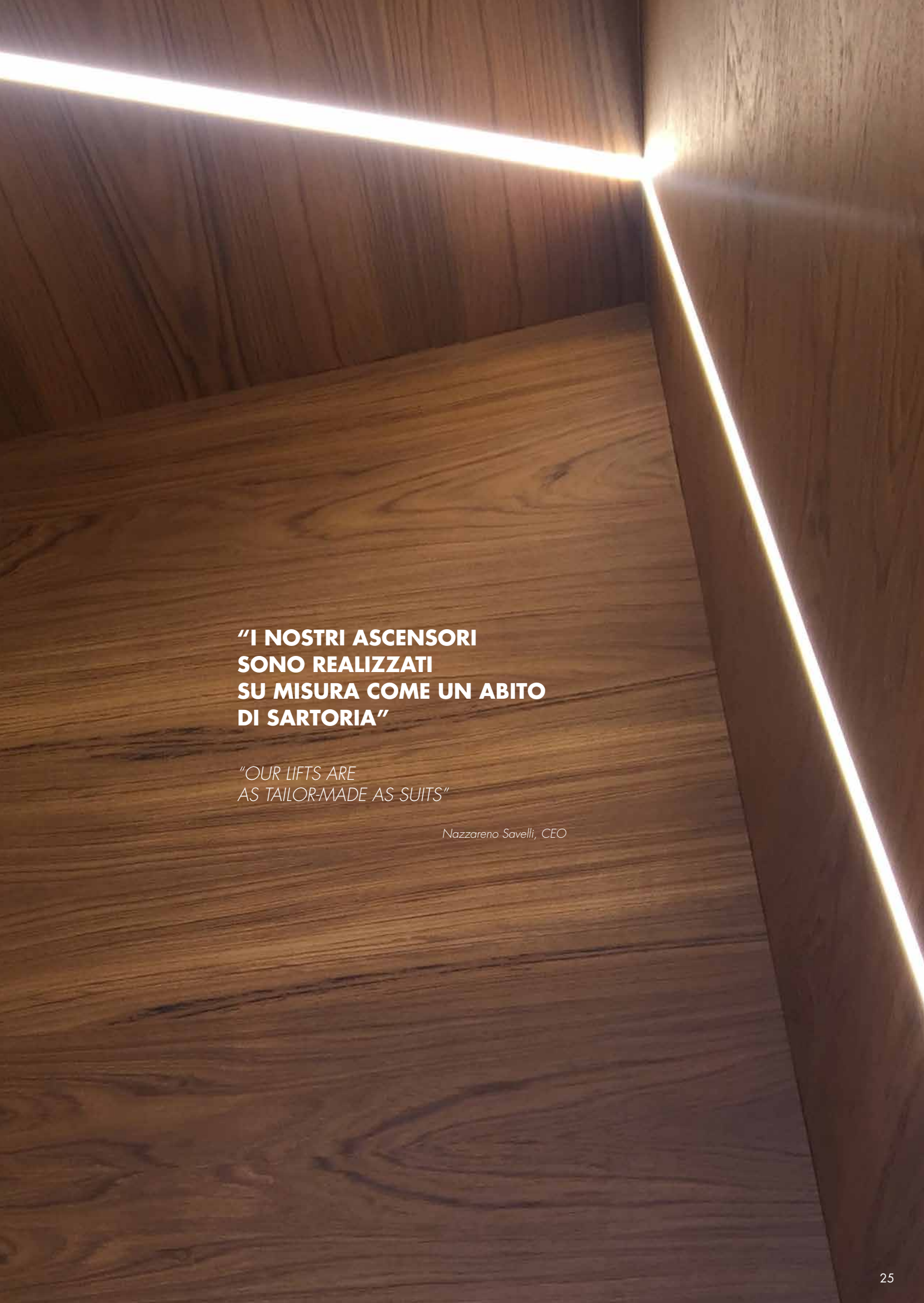

**"I NOSTRI ASCENSORI  
SONO REALIZZATI  
SU MISURA COME UN ABITO  
DI SARTORIA"**

*"OUR LIFTS ARE  
AS TAILOR-MADE AS SUITS"*

*Nazzareno Savelli, CEO*

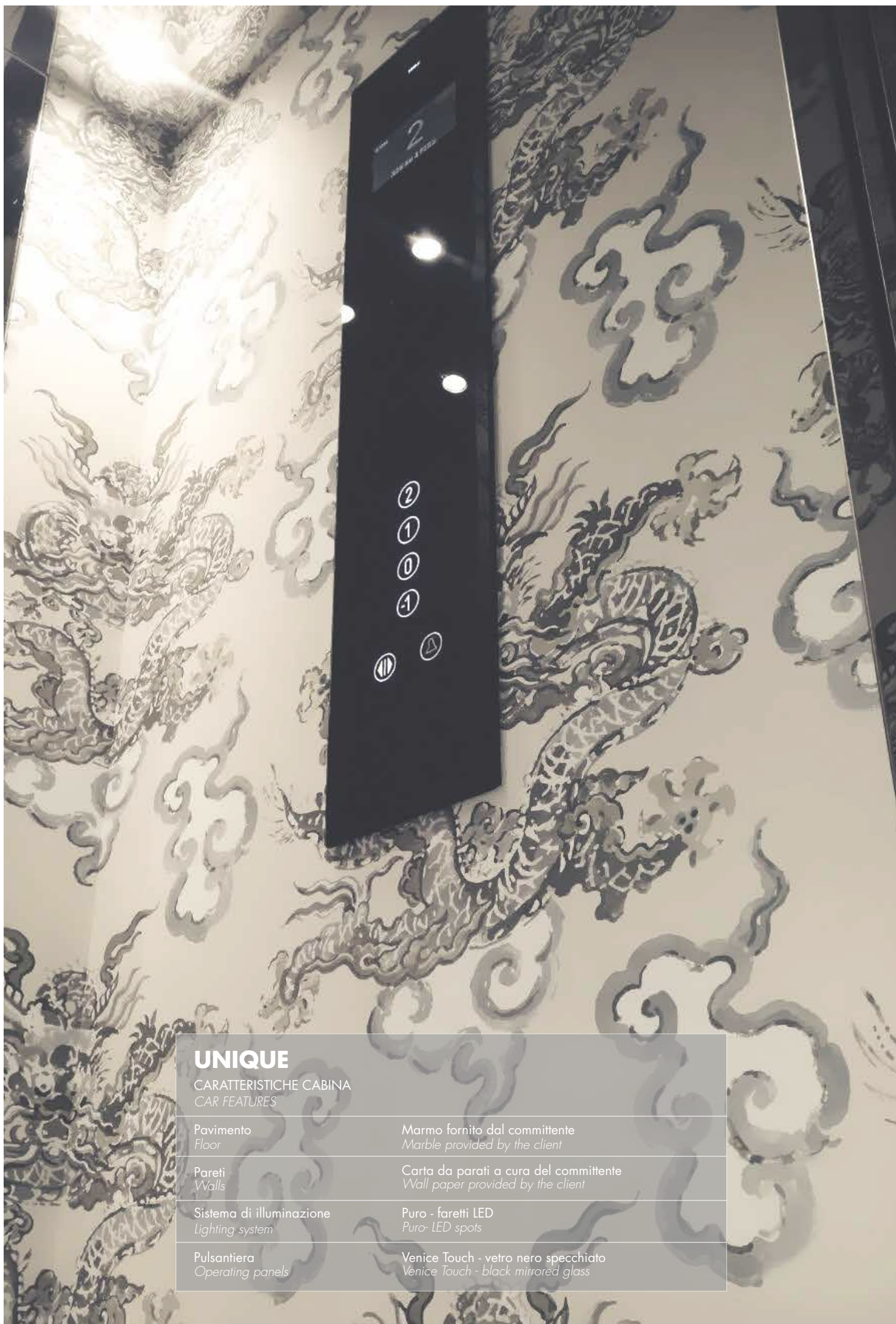

## UNIQUE

### CARATTERISTICHE CABINA CAR FEATURES

Pavimento  
Floor

Marmo fornito dal committente  
Marble provided by the client

Pareti  
Walls

Carta da parati a cura del committente  
Wall paper provided by the client

Sistema di illuminazione  
Lighting system

Puro - faretti LED  
Puro - LED spots

Pulsantiera  
Operating panels

Venice Touch - vetro nero specchiato  
Venice Touch - black mirrored glass

RIVESTIMENTI PARETI / WALL FINISHES

ACCIAIO INOX / STAINLESS STEEL



**S15** Scotch brite  
*Scotch brite*  
**S16** B-A lucido  
*Glossy B-A*  
**S11** Lino  
*Linen*  
**S12** Quadro Square  
*pattern*  
**S10** 5wl lucido  
*Glossy 5wl*  
**S19** Super mirror  
*Super mirror*



**S20** Silver satinato  
*Glazed Silver*  
**S21** Nero satinato  
*Glazed Black*  
**S22** Oro satinato  
*Glazed gold*  
**S23** Blu satinato  
*Glazed Blue*  
**S24** Fucsia satinato  
*Glazed violet*



**S13** Rame a specchio  
*Mirror Copper*

**S18** Bronzo  
*Bronze*

**S14** Oro  
*Gold*

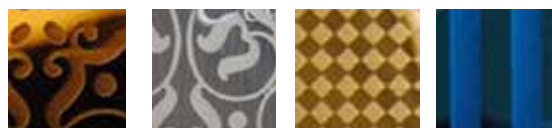

**S31** Flor bronzo  
*Flor bronze*

**S32** Flor silver  
*Flor Silver*

**S33** Quadri oro  
*Gold squares*

**S34** Blu rigato  
*Striped blue*

ALLUMINIO / ALUMINUM



VETRO COLORATO O DECORATO / COLOURED GLASS



CARTA DA PARATI O STAMPA DIGITALE / WALLPAPER OR DIGITAL PRINT

Crea un'atmosfera speciale non solo con i colori, ma anche con forme geometriche o organiche di tuo gusto. Qualunque sia la dimensione della tua cabina, la carta da parati o la decorazione digitale avrà sempre un effetto sorprendente

*Create a special atmosphere not only with colors, but also with geometric or organic shapes of your taste. Regardless of the size of your cabin, the wallpaper or digital decoration will always have an amazing effect.*



MARMO / MARBLE



**M1** Tigrato  
*Tigerskin*

**M2** Miele  
*Honey*

**M3** Avorio  
*Ivory*

**M4** Kryptonite  
*Kryptonite*

**M5** Verde persiano  
*Persian green*

CORIAN



**C1** Bianco  
*White*

**C2** Grigio  
*Grey*

**C3** Marrone  
*Brown*

## UNIQUE

CARATTERISTICHE CABINA A DOPPIO ACCESSO DIAGONALE  
CAR FEATURES

Pavimento <i>Floor</i>	Marmo fornito dal committente <i>Marble provided by the client</i>
Parete 1 <i>Walls 1</i>	Acciaio inox oro S14 <i>S14 Gold stainless steel</i>
Pulsantiera, Aerazione <i>Button panel, Ventilation</i>	Line - Acciaio inox oro S14 <i>Line - S14 Gold stainless steel</i>
Parete 2 <i>Walls 2</i>	Carta da parati a cura del committente <i>Wall paper provided by the client</i>
Sistema di illuminazione <i>Lighting system</i>	Puro - faretto LED <i>Puro - LED spots</i>

PAVIMENTI / FLOORS

PAVIMENTO VINILICO - EFFETTO LEGNO (Doga 178X1219mm) / VINYL FLOOR - WOOD ESSENCE (Slat 178X219mm)



- G1** Rovere invernò  
*Winter durmast*
- G2** Rovere grigio cenere  
*Ash gray durmast*
- G3** Rovere marittimo  
*Maritime durmast*
- G4** Rovere dorato  
*Golden durmast*
- G5** Rovere naturale  
*Natural durmast*
- G6** Rovere cottage  
*Cottage durmast*

PAVIMENTO VINILICO - EFFETTO TENDENCY (Piastra 305X610 mm) / VINYL FLOOR - TENDENCY EFFECT (Slat 178X219)



- G7** Cemento  
*Concrete*
- G8** Ramato  
*Copper*
- G9** Resina grigia  
*Grey resin*
- G10** Beton  
*Beton*

ACCIAIO INOX / STAINLESS STEEL



- P10** Acciaio mandorlato  
*Almond shape*
- P11** Lamiera striata  
*Streaked plate*

MARMO / MARBLE



- M1** Tigrato  
*Tigerskin*
- M2** Miele  
*Honey*
- M3** Avorio  
*Ivory*
- M4** Kryptonite  
*Kryptonite*
- M5** Verde persiano  
*Persian green*

SISTEMI DI ILLUMINAZIONE / LIGHTING SYSTEMS

**NOTA:** su richiesta è possibile realizzare cielini differenti / *On request, it is possible to create different ceilings.*



**PURO**  
CIELINO: lamiera plastificata bianca o acciaio inox  
ILLUMINAZIONE: faretto a LED  
CEILING: white plastic coated steel sheet or stainless steel  
LIGHTING: LED Spots



**TRAMA**  
CIELINO: lamiera plastificata bianca o acciaio inox  
ILLUMINAZIONE: strisce LED  
CEILING: white plastic coated steel sheet or stainless steel  
LIGHTING: LED stripes



**SEGNO**  
CIELINO: lamiera plastificata bianca o acciaio inox  
ILLUMINAZIONE: strisce LED  
CEILING: white plastic coated steel sheet or stainless steel  
LIGHTING: LED stripes



**QUADRO**  
CIELINO: lamiera plastificata bianca o acciaio inox  
ILLUMINAZIONE: modulo LED  
CEILING: white plastic coated steel sheet or stainless steel  
LIGHTING: LED module



**DIFFUSO**  
CIELINO: lamiera plastificata bianca o acciaio inox  
ILLUMINAZIONE: modulo LED  
CEILING: white plastic coated steel sheet or stainless steel  
LIGHTING: LED module



**RAGGIO**  
CIELINO: lamiera plastificata bianca o acciaio inox  
ILLUMINAZIONE: strisce LED  
CEILING: white plastic coated steel sheet or stainless steel  
LIGHTING: LED stripes







## UNIQUE

### CARATTERISTICHE CABINA CAR FEATURES

Pareti  
Walls

Rivestite con pannelli decorati a mano  
Covered with panels decorated by hands

Porte di cabina  
Car doors

Rivestite con pannelli decorati a mano  
Covered with panels decorated by hands

Pulsantiera  
Button panel

Line Colour - display TFT 7"  
Line Colour - TFT 7" display

Sistema di illuminazione  
lighting system

Zeta - strisce LED  
Zeta - LED stripes

**BOTTONIERE / OPERATING PANELS**

**VENICE TOUCH**

Finiture: vetro specchiato nero o bianco  
 Finishes: black or white mirrored glass



1. Colonna  
*Column*
2. Piastra di piano con freccia  
*Landing panel with arrows*
3. Piastra di piano con TFT e freccia  
*Landing panel with TFT indicator and arrows*

**ITALIA SOFT**



1. Pulsantiera di cabina piana, in acciaio inox e vetro  
*Faceplate Lop in stainless steel and glass*
2. Pulsantiera di piano piana in acciaio inox scotch brite con display + 1 pulsante  
*Faceplate Cop in Scotch brite with a display and 1 button*

**NEW BRICK TOUCH**

vince il Good Design Award 2015  
 Has won the Good Design Award 2015



1. Colonna in Corian® Dupont TM, ergonomica, traslucida e con tecnologia touch  
*Ergonomic, translucent Corian® DupontTM column with touch technology*
2. LOP con display e 1 o 2 pulsanti  
*LOP with display and 1 or 2 push buttons*

**NEW MARBLE TOUCH**



1. Colonna in marmo, con tecnologia touch  
*Marble column with touch technology*
2. LOP con display e 1 o 2 pulsanti  
*LOP with display and 1 or 2 push buttons*

FLORENCE

Finiture: scotch brite, inox lucido, oro satinato\* e oro lucido\*  
 Finishes: scotch brite, glossy inox, satin gold and mirror gold



Pulsantiera di cabina in acciaio inox con display TFT  
 Stainless steel COP with TFT display



Pulsantiera di cabina in acciaio inox con particolare forma TFT  
 Stainless steel COP with special TFT display

FLORENCE



Bottoniera di piano in acciaio inox, 1 pulsante + display  
 Stainless steel LOP, 1 button + display



Bottoniera di piano in acciaio inox, 2 pulsanti  
 Stainless steel LOP, 2 button + display



Bottoniera di piano in acciaio inox, 1 pulsante  
 Stainless steel LOP, 1 button

LINE COLOUR

Finitura: disponibile nello stesso materiale delle pareti della cabina  
 Finish: same car wall materials available



Colonna a filo e ad altezza cabina con display TFT  
 Full height cabin column and flush mounting with TFT display

LINE+



Pulsantiera di cabina a filo disponibile nelle stesse finiture della cabina, con display TFT + strisce LED  
 Full height cabin column with TFT display and LED stripes available in the same wall materials

BUGATTI - BOTTONIERA DI PIANO / BUGATTI

Finiture: scotch brite, nero\*, madreperla\*, lucida\* (cromo e oro), oro lucida\* e oro satinato\*  
 Finishes: scotch brite stainless steel, black\*, Pearl \* and mirrored [chrome and gold]\*



Acciaio inox, 1 pulsante + display  
 Stainless steel, 1 button + display



Acciaio inox, 2 pulsanti  
 Stainless steel, 1 button + display



Acciaio inox, 2 pulsanti  
 Stainless steel, 1 button + display

MINIMAL

Finiture: acciaio inox scotch brite, lucido, mirror, oro\* e oro satinato\* (su richiesta altre finiture)  
 Finishes: scotch brite, glossy inox, satin gold\* and mirror gold\* (on request other finishes)



Acciaio inox, 1 pulsante  
 Stainless steel, 1 button





**LA SOLUZIONE SEMPRE  
PERFETTA DISEGNATA  
DA TE, PER TE**  
*YOU ALWAYS DESIGN THE PERFECT  
SOLUTION FOR YOU*

Cabina in acciaio super mirror e stampa digitale  
personalizzata  
*Super mirror steel car with customized digital print*

**SPECCHIO / MIRROR**

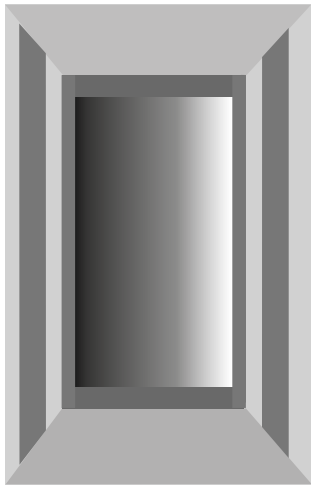

**RIFLESSO**  
Specchio a tutta altezza intelaiato  
*Full-wall mirror with protection frame*

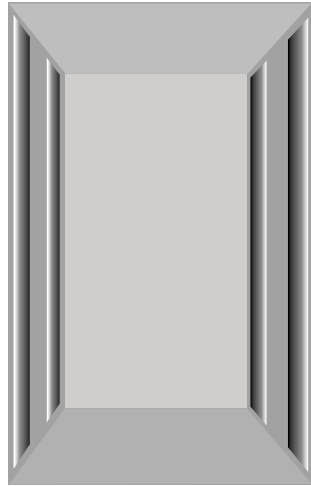

**PROIEZIONE**  
Specchi laterali a tutta altezza  
*Full-wall mirrors with protection frames on wall sides*

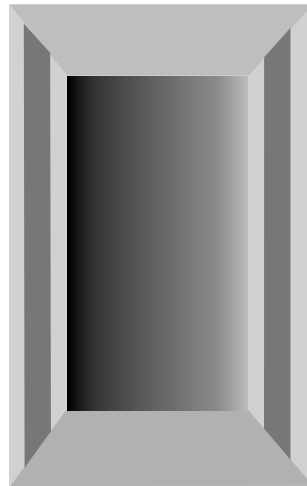

**STRASCICO**  
Specchio a tutta altezza  
*Full-wall mirror*

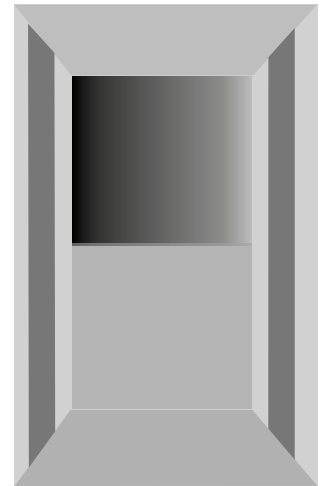

**OMBRA**  
Specchio a metà altezza  
*Half-wall mirror*

**CORRIMANO / HANDRAIL**



**ORBITA**  
Corrimano cromato fissato su parete  
*Chrome-coated handrail, fixed to the panel*



**ECLISSE**  
Corrimano cromato incassato su parete  
*Chrome-coated handrail, built into the panel*

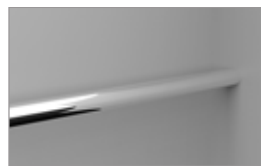

**AURORA**  
Corrimano acciaio inox  
*Stainless steel handrail*



## UNIQUE

CARATTERISTICHE CABINA  
CAR FEATURES

Pavimento  
Floor

Marble  
Marble

Pareti  
Walls

Boiserie bianca  
White boiserie

Pulsantiera, Aerazione,  
Button panel, Ventilation, angle  
profiles

Acciaio inox mirror e swarovski  
Mirror stainless steel and swarovski

Cielino  
Ceiling

Segno - strisce LED  
Segno - LED stripes

Porte  
Doors

Acciaio inox super mirror  
Super mirror stainless steel

# PORTE

## DOORS

Un look impeccabile in ogni dettaglio  
*An impeccably detailed look*





# PORTE DI PIANO - FLOOR DOORS

## PORTA AUTOMATICA SENZA RIQUADRATURA

*Automatic door without squaring frame*

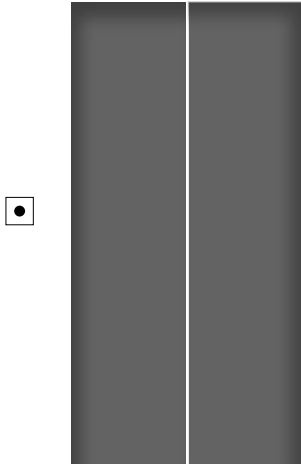

## PORTA AUTOMATICA CON RIQUADRATURA IN MARMO O LEGNO

*Automatic door with marble or wood  
squaring frame provided by the client*

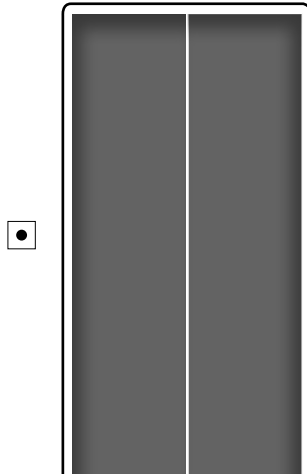

## PORTA AUTOMATICA CON RIQUADRATURA

*Automatic door with squaring frame*

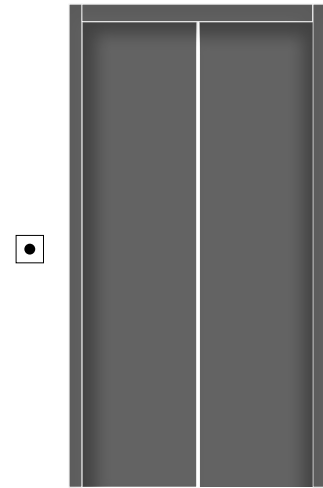

## PORTA AUTOMATICA CON TELAIO

*Automatic door with frame*

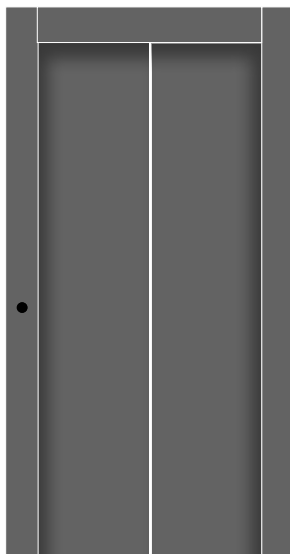

## PORTA AUTOMATICA IN VETRO INTELAIATO

*Automatic glass door with frame*

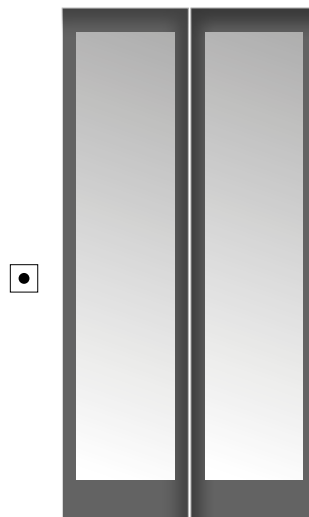

## PORTA AUTOMATICA IN VETRO PORTANTE

*Automatic glass door*

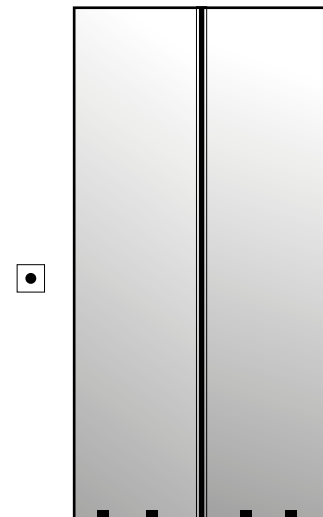

## PORTA DI PIANO A SOFFIETTO

*Automatic folding door*

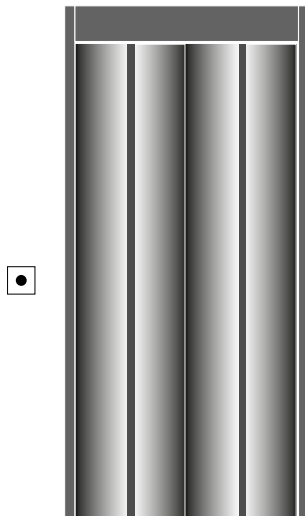

## PORTA A BATTENTE IN LAMIERA VERNICIATA

*Painted sheet swing door*

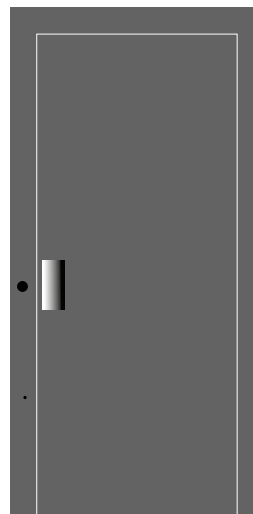

## PORTA A BATTENTE IN ALLUMINIO E VETRO

*Aluminum and glass swing door*

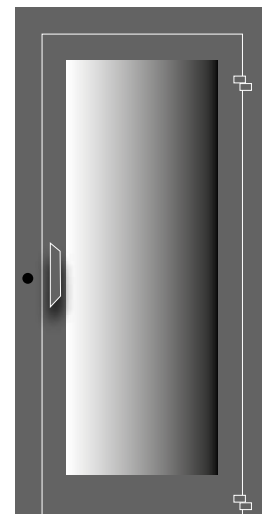

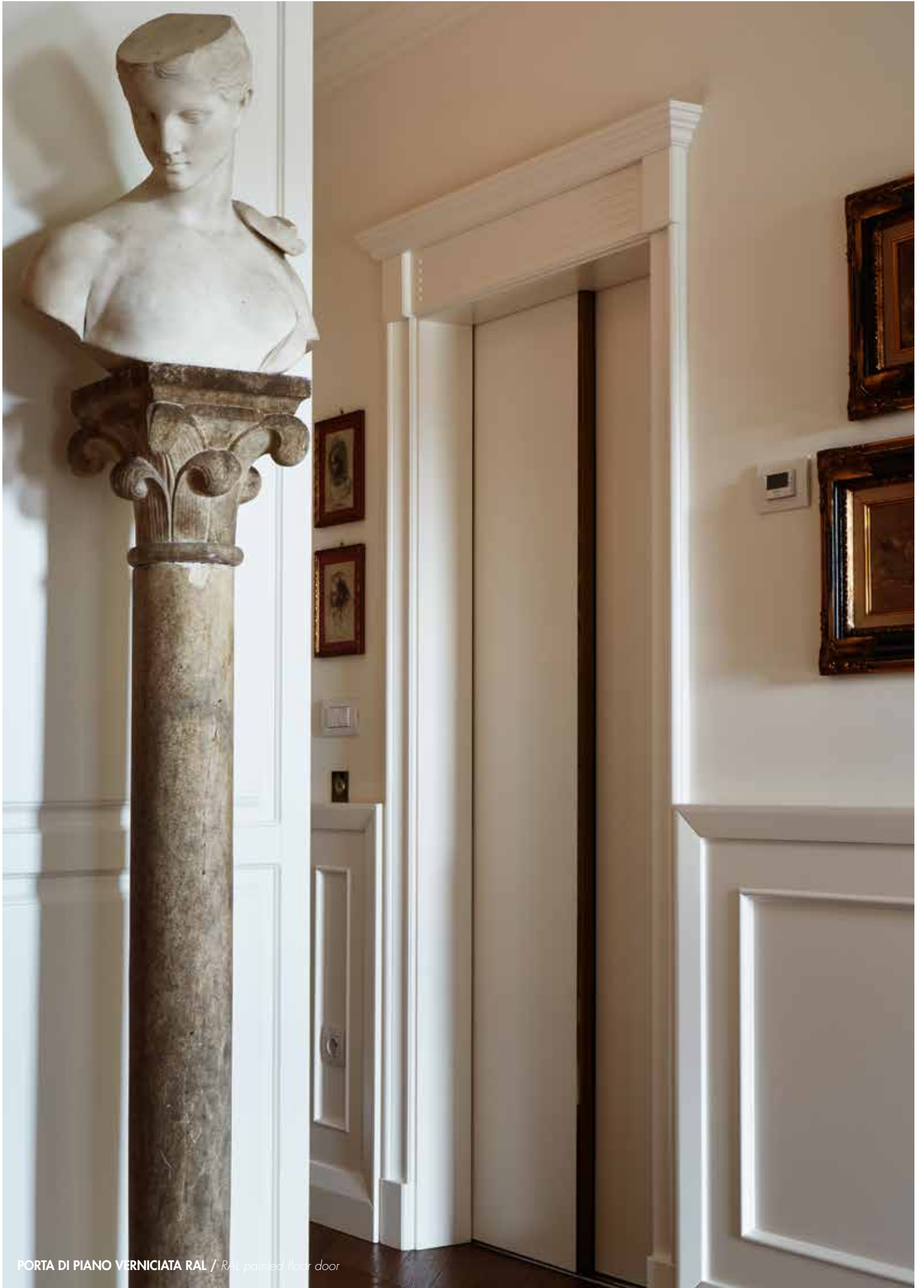

PORTA DI PIANO VERNICIATA RAL / *RAL painted floor door*



**PORTA DI PIANO  
IN LAMIERA PLASTIFICATA S9 GRIGIO METALLIZZATO**  
*S9 Glossy grey plastic coated steel sheet floor door*



**PORTA DI PIANO  
E DI CABINA IN VETRO PORTANTE**  
*Glass doors*



**PORTA DI PIANO E DI CABINA IN VETRO PORTANTE**  
*Glass doors*



**Infiniti modi di personalizzare i tuoi display grazie alla nuova gamma di TFT.**

*You can always customize your TFT with all kind of picture*

## DISPLAY LCD / LCD DISPLAY



### TRICOLOR

1. Display LCD di cabina  
*LCD car indicator*
2. Display LCD di piano  
*LCD landing indicator*

### FUNZIONI PRINCIPALI

- Schermo: in policarbonato trasparente antiurto e antigraffio
- Freccia salita discesa

### MAIN FEATURES

- LCD model: car indicator LCD available in blue or background
- Screen: lens polycarbonate (shock-proof and anti crash)
- Up and down arrow

## DISPLAY TFT / TFT DISPLAY



### IRIS EXCELLENCE

1. Display alta risoluzione per cabina, linea excellence  
*Excellence line, high resolution car indicator*
2. Display TFT di piano  
*TFT landing position indicator*

### FUNZIONI PRINCIPALI

- Completamente personalizzabile (sfondo, frecce, piani, logo e segnali).
- Sintesi vocale integrata
- Gestione immagini alta risoluzione
- Riproduzione musica e audio ad alta qualità
- Riproduzione video alta risoluzione
- Orologio analogico e digitale
- USB Host connectivity
- Aggiornamento tramite SD Card
- Connettività LAN
- Uscita video: HDMI

### MAIN FEATURES

- Customizable background, arrows, floor, logo and signs
- Voice synthesizer integrated
- HD Images management
- High quality Music and audio player
- HD Video player
- Analog and digital clock
- USB HOST connectivity
- SD Card updating
- LAN connection
- HDMI video output

IRIS 7"  
154.1 X 86 mm

IRIS 10.1" 222.72 X

IRIS 15.6" 344.2 X

Area visibile / Visible Area



IRIS 21.5"  
476.64 X 268.11 mm

IRIS 18.5"  
409.8 X 230.4 mm

IRIS 15.6"  
344.2 X 193.5 mm

Area visibile / Visible Area

### IRIS TOUCH

Display touch alta risoluzione.  
*HD touch display*

### FUNZIONI PRINCIPALI

- Completamente touch con sfondi, frecce, loghi e segnalazioni personalizzabili
- Risoluzione Full HD
- Possibilità di aggiornare video o musica
- Sintesi vocale integrato
- Orologio integrato

### MAIN FEATURES

- Completely touch with customizable background, arrows, floors, logo and signs
- Full HD resolution
- Updatable music and video
- Voice synthesizer
- Integrated clock

CONTATTO A CHIAVE CIRCOLARE / ILLUMINATED EMERGENCY LIGHT



Contatto a chiave luminoso per abilitare l'utilizzo dell'ascensore solo a persone autorizzate, in condomini o ambienti professionali in cui è richiesto un particolare controllo sull'accesso

*Illuminated emergency light to enable the use of the lift by authorized people only, where an access control is required.*

CHIAVE ELETTRONICA / ELECTRONIC KEY



**I-BUTTON EVO**

Chiave elettronica antivandalo per il controllo degli accessi in ascensore

*Electronic key to check accesses in lift.*



**RFID**

Letto di prossimità per il controllo degli accessi in ascensore. Funzionante con BADGE /TAGS di prossimità

*Proximity reader to check accesses in lift. It works with TAGS and proximity cards.*



**STICKERS**

Etichette adesiva di prossimità per il controllo degli accessi in ascensore

*Sticky proximity cards to check accesses in lift*

LETTORE E CONTROLLER IN UN UNICO PRODOTTO / READER AND CONTROLLER IN A ONLY PRODUCT



**C-RFID EM IP**

È un controller per la limitazione dell'uso di un ascensore con lettore integrato di chiavi elettroniche.

*This controller limits the lift use through integrated reader of electronic keys*



**C-CODE EM**

È un dispositivo per il comando locale dell'automazione attraverso un codice numerico

*This device control the automation locally through a numerical code*



**C-BIOMETRIC**

È un controller per la limitazione dell'uso di un impianto ascensoristico, con lettore integrato di impronte digitali e di chiavi elettroniche

*This controller limits the lift use through integrated reader of fingerprints and electronic keys*



**C-BLUETOOTH**

È un controller per la limitazione dell'uso di un impianto ascensoristico, con ricevitore bluetooth integrato. Lo smartphone sarà il proprio strumento d'identificazione personale

*This controller limits the lift use through integrated bluetooth receiver. Your smartphone will be your identification tool*



ACCESSO SINGOLO / SINGLE ACCESS

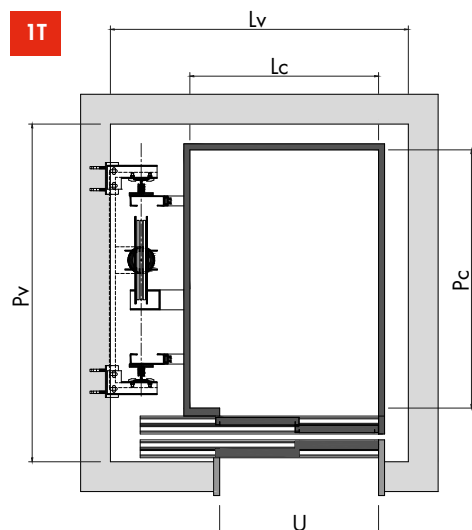

PORTE AUTOMATICHE TELESCOPICHE / AUTOMATIC TELESCOPIC DOORS

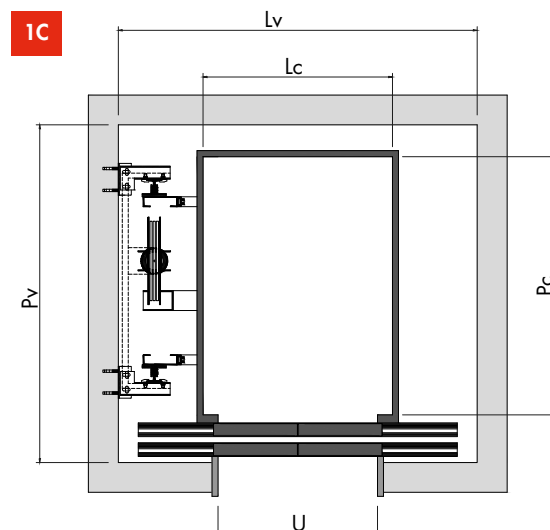

PORTE AUTOMATICHE CENTRALI / AUTOMATIC CENTRAL DOORS

DOPPIO ACCESSO FRONTALE / FRONTAL DOUBLE ACCESS

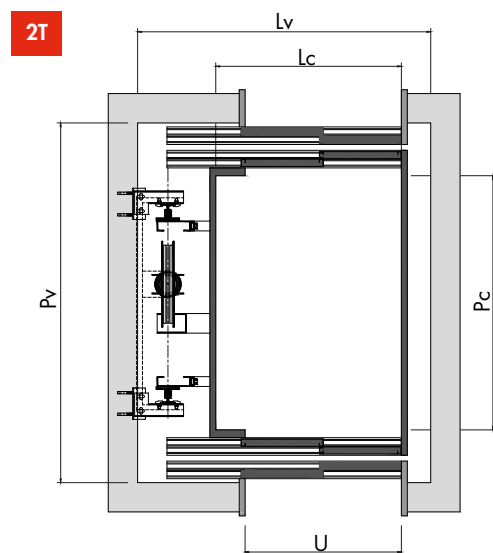

PORTE AUTOMATICHE TELESCOPICHE / AUTOMATIC TELESCOPIC DOORS

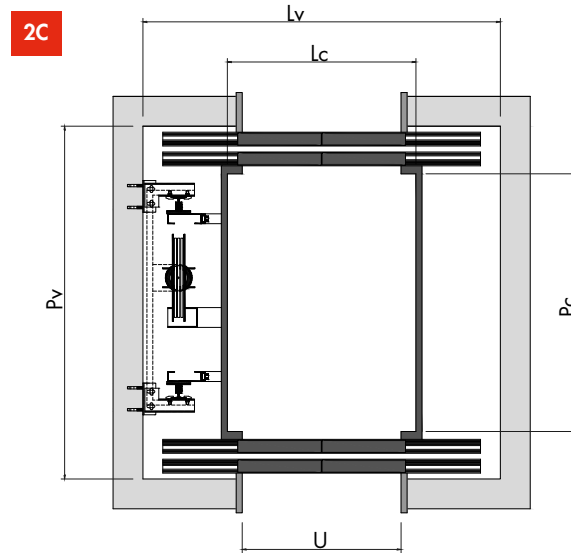

PORTE AUTOMATICHE CENTRALI / AUTOMATIC CENTRAL DOORS

DOPPIO ACCESSO DIAGONALE / FRONTAL DOUBLE ACCESS

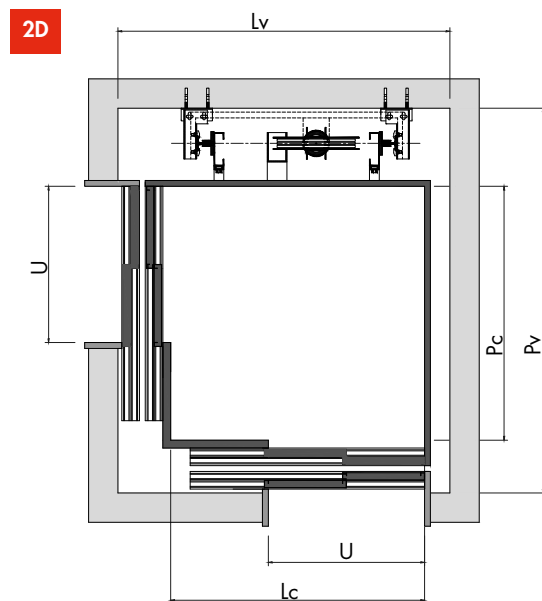

PORTE AUTOMATICHE TELESCOPICHE / AUTOMATIC TELESCOPIC DOORS

**NOTA:**

le quote riportate nelle tabelle rispettano le normative italiane L13/89 e DM 236/89 e comunitarie 81-20/50 e 81-70. Per qualunque altra esigenza rivolgersi ai nostri uffici, saremo lieti di soddisfare qualsiasi vostra richiesta

**NOTE:**

The sizes in the charts comply with the Italian law L13/89 and DM 236/89, EU law 81-20/50 and 81-70. Do not hesitate to contact our office for further information. We are certainly pleased to meet your requirements.



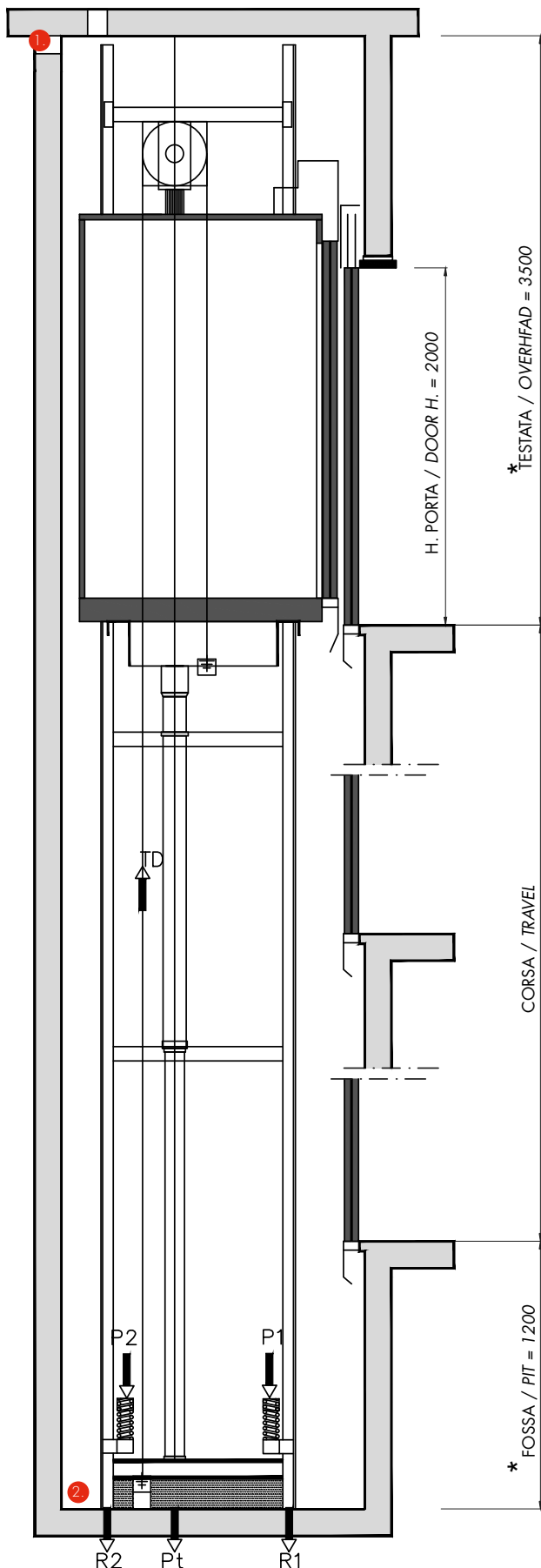

**EDIFICI RESIDENZIALI DI NUOVA COSTRUZIONE / NEW RESIDENTIAL**

Impianto Installation	Portata Kg Load Kg	Persone People	Dimensione cabina (mm) Car Sizes (mm)		Porte (mm) Doors (mm)	Dimensioni Vano Shaft sizes (mm)	
			Lc	Pc	U	Lv	Pv
1T	480	6	950	1300	800	1500	1700
1C	480	6	950	1300	800	1700	1600
2T	480	6	950	1300	800	1500	1780
2C	480	6	950	1300	800	1700	1680
2D*	700	9	1300	1300	800	1950	1700

\*Per ascensore Gearless prevedere larghezza utile vano > 50 mm  
\*For Gearless elevator plan a shaft width > 50 mm

LE DIMENSIONI DELLA FOSSA E DELLA TESTATA POTREBBERO VARIARE A SECONDA DEL TIPO DI IMPIANTO. PER ULTERIORI INFORMAZIONI CONTATTARE IL NOSTRO UFFICIO TECNICO.

\*PIT AND OVERHEAD DIMENSIONS MAY CHANGE ACCORDING TO THE TYPE OF ELEVATOR.

**EDIFICI RESIDENZIALI PREESISTENTI / PREEXISTING RESIDENTIAL**

Impianto Installation	Portata Kg Load Kg	Persone People	Dimensione cabina (mm) Car Sizes (mm)		Porte (mm) Doors (mm)	Dimensioni Vano Shaft sizes (mm)	
			Lc	Pc	U	Lv	Pv
1T	400	5	850	1200	750	1300	1550
1C	400	5	850	1200	750	1600	1500
2T	400	5	850	1200	750	1300	1680
2C	400	5	850	1200	750	1600	1580
2D*	600	7	1200	1200	750	1800	1600

Per ascensore Gearless prevedere larghezza utile vano > 50 mm  
For Gearless elevator plan a shaft width > 50 mm

LE DIMENSIONI DELLA FOSSA E DELLA TESTATA POTREBBERO VARIARE A SECONDA DEL TIPO DI IMPIANTO. PER ULTERIORI INFORMAZIONI CONTATTARE IL NOSTRO UFFICIO TECNICO.

\*PIT AND OVERHEAD DIMENSIONS MAY CHANGE ACCORDING TO THE TYPE OF ELEVATOR.

**EDIFICI NON RESIDENZIALI / NON-RESIDENTIAL BUILDING**

Impianto Installation	Portata Kg Load Kg	Persone People	Dimensione cabina (mm) Car Sizes (mm)		Porte (mm) Doors (mm)	Dimensioni Vano Shaft sizes (mm)	
			Lc	Pc	U	Lv	Pv
1T	630	8	1100	1400	900	1600	1800
1C	630	8	1100	1400	900	1900	1700
2T	630	8	1100	1400	900	1600	1880
2C	630	8	1100	1400	900	1900	1780
2D*	800	10	1400	1400	900	2150	1800

\*Per ascensore Gearless prevedere larghezza utile vano > 50 mm  
\*For Gearless elevator plan a shaft width > 50 mm

LE DIMENSIONI DELLA FOSSA E DELLA TESTATA POTREBBERO VARIARE A SECONDA DEL TIPO DI IMPIANTO. PER ULTERIORI INFORMAZIONI CONTATTARE IL NOSTRO UFFICIO TECNICO.

\*PIT AND OVERHEAD DIMENSIONS MAY CHANGE ACCORDING TO THE TYPE OF ELEVATOR.

1. Alla sommità del vano corsa prevedere apertura per aerazione regolamentare pari al 1% della superficie in pianta da portare verso l'esterno dell'edificio. Per impianti con prescrizione incendi, prevedere tale apertura pari al 3% della superficie in pianta del vano con un minimo di 0,20 mq.  
At the top of the shaft, plan a regulatory ventilation opening equal to 1% of the surface to bring outside the building; For fire elevator plan this opening equal to 3% of the shaft surface with a minimum of 0,20 mq.
2. Prevedere perfetta impermeabilizzazione della fossa all'interno del vano  
Provide perfect waterproofing of the pit.

**ARMADIO ASCENSORE STANDARD FINO A PORTATA 630 KG**  
 STANDARD ELEVATOR CABINET UP TO 630 KG

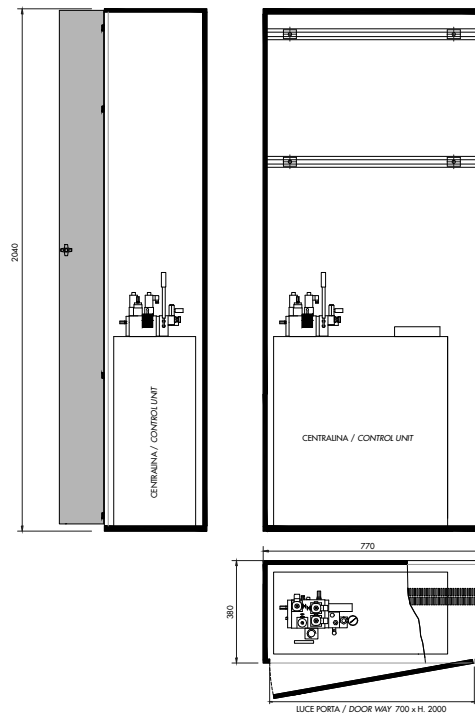

**IL LOCALE DOVE VERRÀ INSTALLATO L'ARMADIO DOVRÀ ESSERE CONVENIENTEMENTE VENTILATO.**  
 THE CABINET MUST BE INSTALLED IN A PROPERLY AIRED PLACE

**ARMADIO ASCENSORE GEARLESS SU STIPITE / CABINET ON JAMB**  
 FOR GEARLESS ELEVATOR

**ARMADIO ASCENSORE GEARLESS STANDARD / STANDARD**  
 CABINET FOR GEARLESS ELEVATOR

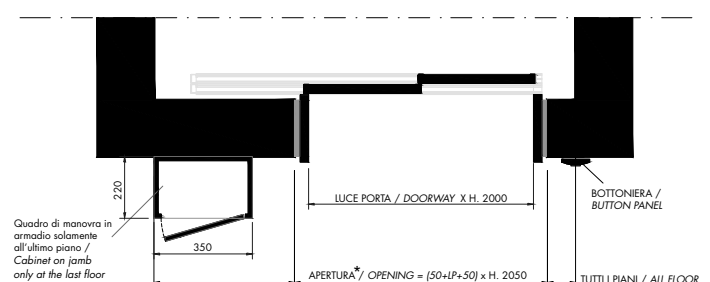
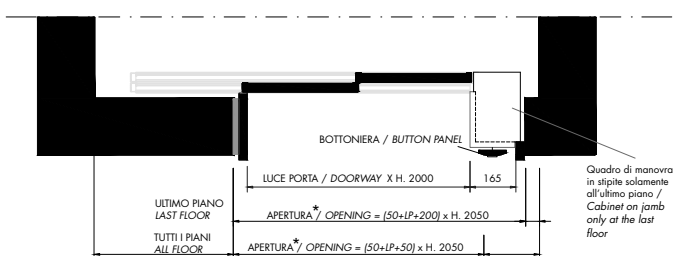
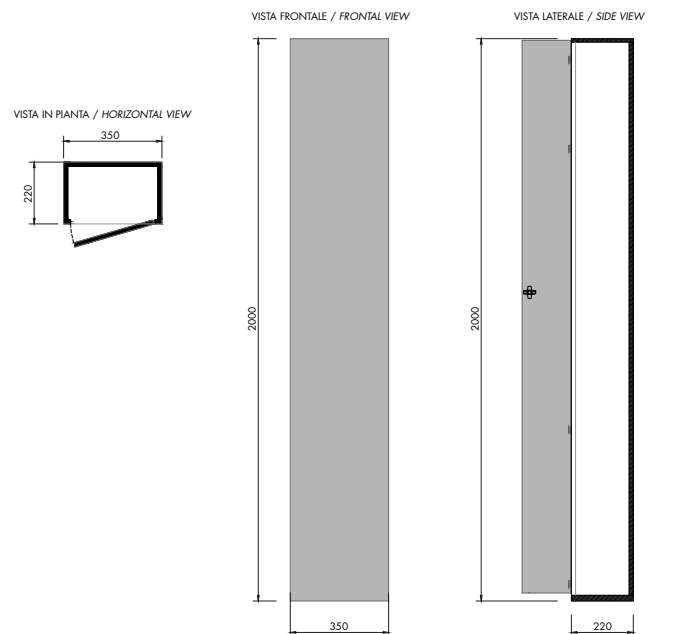
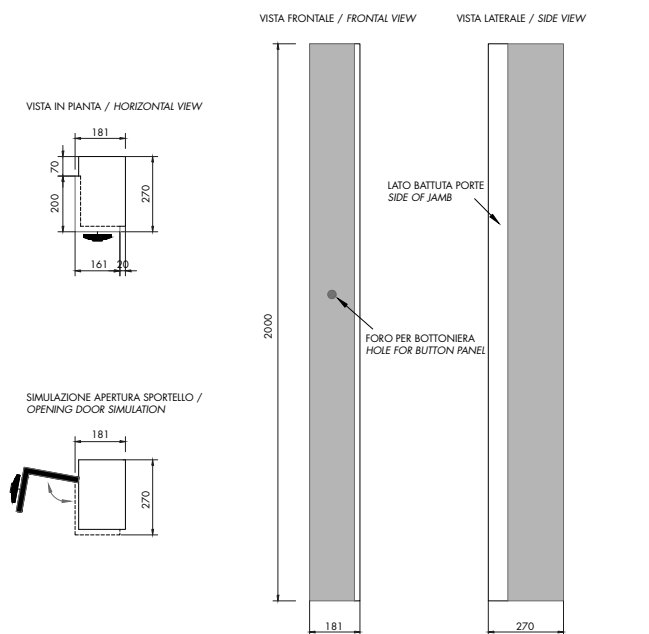

\*muratura da prevedere nel caso di riquadratura porta in marmo; rivolgersi ai nostri uffici per altre tipologie di riquadrature - masonry to be provided in case of a marble door frame; contact our offices for other types of frames



**SAVELLI ASCENSORI SRL**

Contrada Storno, 13 B/C - 63900 Fermo  
Tel: +39 0734 228928 P.IVA 01865710444  
savelli@savelliascensori.it

[www.savelliascensori.it](http://www.savelliascensori.it)

La presente pubblicazione è a solo scopo informativo e ci riserviamo il diritto di modificare i contenuti in qualunque momento. Nessuna dichiarazione contenuta in questa brochure deve essere ritenuta garanzia o condizione, esplicita od implicita, relativamente a qualsiasi prodotto, della sua idoneità per scopi particolari, della sua commerciabilità, qualità o interpretazione dei termini di qualsiasi contratto d'acquisto.

Potrebbero esserci piccole differenze tra i colori stampati e quelli reali.

This publication is only an informative document. Savelli Ascensori reserves the right to modify the content at any time.

There could be differences between the printed colors and those real.

2020 rev.02

---

Tutti i diritti riservati. All rights reserved