



DESIGN COLLECTION

The excellence of Italian Products



SCEGLI LA TUA CABINA

CHOOSE YOUR ELEVATOR CABIN

01. ESSENTIAL _____ pag. 04
L'ascensore minimal / The minimal elevator

02. CLASSIC _____ pag. 08
La semplicità nella scelta degli interni di cabina / Simplicity in the choice of car interiors

03. COMFORT _____ pag. 14
L'ascensore sofisticato / The sophisticated elevator

04. UNIQUE _____ pag. 21
La soluzione sempre perfetta, disegnata per te / Always the perfect solution, designed for you

PORTE - DOORS _____ pag. 36
Un look impeccabile in ogni dettaglio / An impeccably detailed look

DISPLAY - DISPLAY _____ pag. 40
Infiniti modi di personalizzare i tuoi display / You can always customize your display

ACCESSORI - ACCESSORIES _____ pag. 42

DATI PER LA PROGETTAZIONE - TECHNICAL DATA SHEET _____ pag. 44





Un premio all'alto Design Italiano

**La Savelli Ascensori
vince il Good Design Award grazie
all'innovativo ascensore Over View.**

La Savelli Ascensori è stata premiata come
azienda più innovativa insieme alle più
importanti multinazionali al mondo.

An award for Italian Design

***Savelli Ascensori wins
the Good Design Award (Chicago) thanks to
the innovative OverView elevator.***

*Savelli Ascensori has been awarded the most
innovative company together with the most
famous multinationals of the world.*

01

ESSENTIAL

L'ascensore minimal
The minimal elevator

La collezione Essential offre uno stile lineare nei rivestimenti e negli accessori di cabina e di piano.

The Essential collection offers a linear style for coverings and accessories of cars and floors.

ESSENTIAL

CARATTERISTICHE CABINA
CAR FEATURES

Pavimento
Floor

Linoleum P7 Grigio
P7 Grey Linoleum

Pareti
Walls

Lamiera plastificata R2 Bianco
R2 White plastic-coated steel sheet

Pulsantiera
Button panel

Line - lamiera plastificata R2 Bianco
Line - R2 White plastic-coated steel sheet

Corrimano
Handrail

Orbita - acciaio cromato fissato su parete the wall panel
Luce - chrome-plated handrail, fixed to the wall panel

Sistema di illuminazione
Lighting system

Puro - faretti a LED
Puro - LED spots

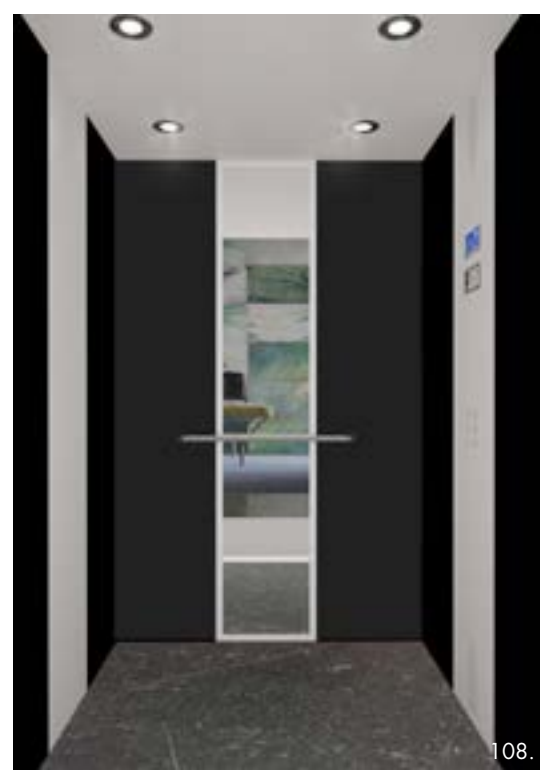

RIVESTIMENTI PARETI / WALL FINISHES

LAMIERA PLASTIFICATA / PLASTIC COATED STEEL SHEET



PAVIMENTI / FLOORS

LINOLEUM / LINOLEUM



NOTA: su richiesta è possibile predisporre il fondo per qualsiasi tipo di pavimento fornito dal cliente.
On request, it is possible to arrange the cabin bottom for any type of floor provided by the customer.

PULSANTIERE / BUTTON PANEL

PULSANTIERA DI CABINA
 CAR BUTTON PANEL



LINE
 Montaggio a filo, disponibile negli stessi materiali dei rivestimenti delle pareti
Fush mounting, same wall materials available

PULSANTIERA DI PIANO
 FLOOR BUTTON PANEL



FLORENCE
 Acciaio inox, 1 pulsante
Stainless steel, 1 button



MINIMAL
 Acciaio inox, 1 pulsante
Stainless steel, 1 button



ESSENTIAL CHIC

CARATTERISTICHE CABINA
CAR FEATURES

Pavimento <i>Floor</i>	Linoleum P2 Sabbia marmorizzato <i>P2 Marbled sand Linoleum</i>
Pareti <i>Walls</i>	Lamiera plastificata R2 Bianco <i>R2 White plastic-coated steel sheet</i>
Pulsantiera <i>Button panel</i>	Line - lamiera plastificata R2 Bianco <i>Line - R2 White plastic-coated steel sheet</i>
Corrimano <i>Handrail</i>	Orbita - cromato fissato su parete <i>Orbita - chrome-plated, fixed to the wall panel</i>
Sistema di illuminazione <i>Lighting system</i>	Puro - faretti a LED <i>Puro - LED Spots</i>
Specchio <i>Mirror</i>	Sfumatura - larghezza parziale, altezza totale <i>Sfumatura - total height, partial width</i>

SISTEMA DI ILLUMINAZIONE / LIGHTING SYSTEM



PURO

CIELINO: lamiera plastificata
bianca
ILLUMINAZIONE: faretti a LED
CEILING: white plastic coated
steel sheet
LIGHTING: LED Spots

SPECCHI*/MIRRORS*

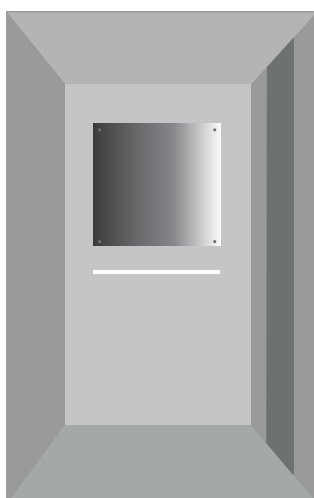

VELO*

Specchio fissato su parete
Mirror fixed to the wall panel

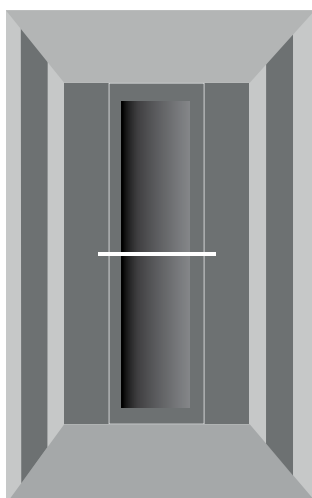

SFUMATURA*

Larghezza parziale, altezza totale
Partial width, total height

CORRIMANO / HANDRAIL

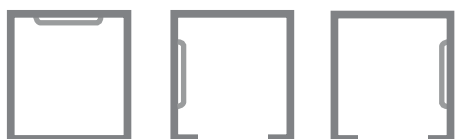

ORBITA

Corrimano in acciaio cromato
fissato su parete
Chrome-plated handrail, fixed to the
wall panel

02

CLASSIC

La semplicità nella scelta degli interni di cabina
Simplicity in the choice of car interiors

La collezione Classic, offre soluzioni classiche e funzionali pensate per farsi notare e adattarsi all'ambiente circostante.

Savelli Ascensori propone una gamma di materiali accessibili per allestire armoniosamente il vostro ascensore.

The Classic collection offers classical and functional solutions created to be noticed and to blend with the surrounding environment.

Savelli Ascensori proposes a range of materials to furnish your elevator harmoniously.

CLASSIC

CARATTERISTICHE CABINA
CAR FEATURES

Pavimento
Floor

Linoleum P4 Nero marmorizzato
P4 Marbled black Linoleum

Pareti
Walls

Lamiera plastificata R3 Nero
R3 Black plastic-coated steel sheet

Pulsantiera e profili
Button panel and profiles

Line - Lamiera plastificata R2 Bianco
Line - R2 White plastic-coated steel sheet

Corrimano
Handrail

Eclisse - inox cromato fissato su parete
Eclisse - chrome-coated, built into the panel

Sistema di illuminazione
Lighting system

Puro - faretti a LED
Puro - LED Spots

Specchio
Mirror

Luce - specchio a mezza parete
Luce - half wall mirror



109.



110.



111.



112.



113.



114.



115.



116.



117.

RIVESTIMENTI PARETI / WALL FINISHES

LAMIERA PLASTIFICATA / PLASTIC COATED STEEL SHEET

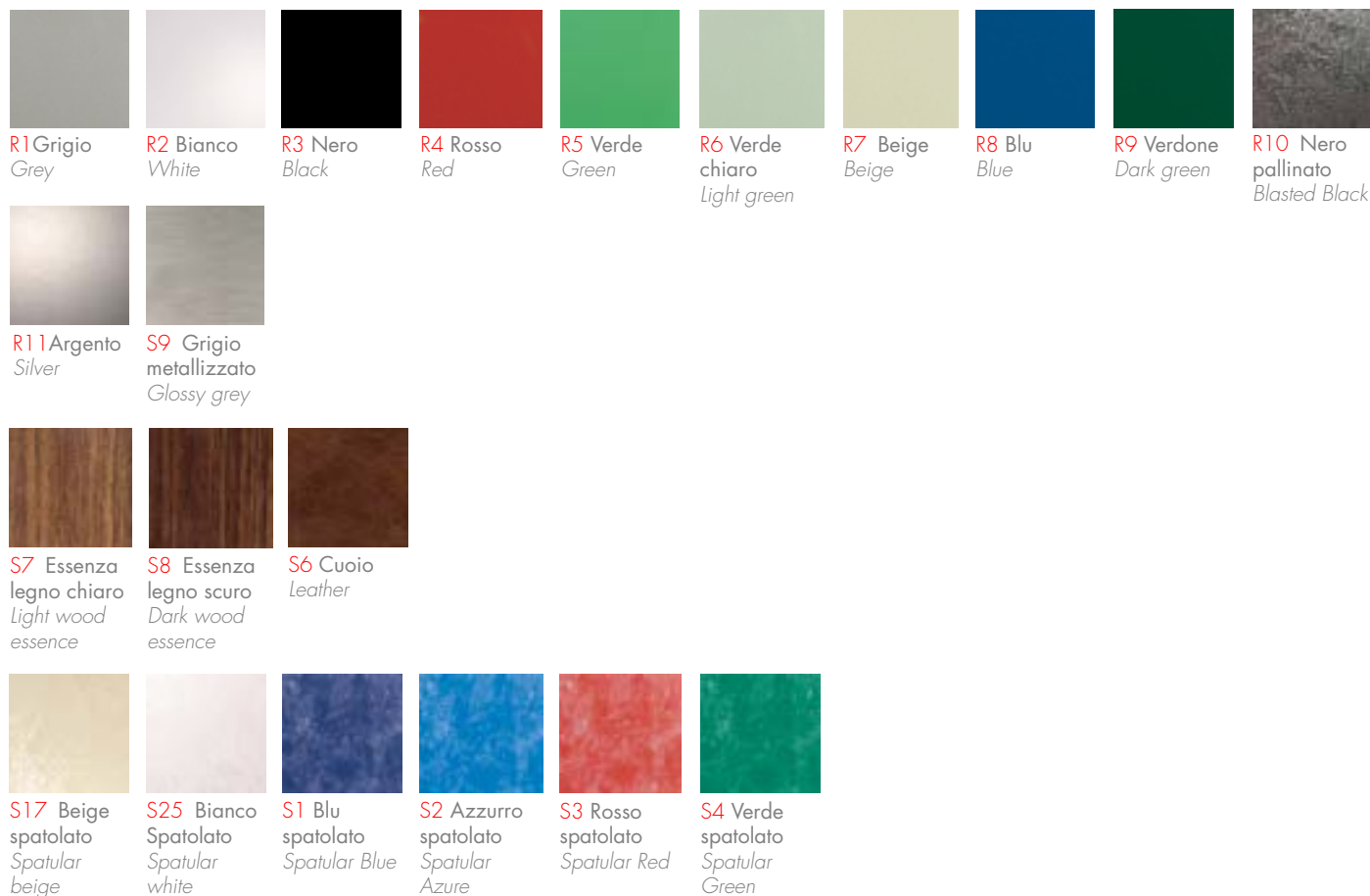

PAVIMENTI / FLOOR

LINOLEUM / LINOLEUM



GOMMA / RUBBER



PAVIMENTO VINILICO / VINYL FLOOR

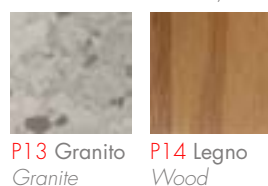

CLASSIC

CARATTERISTICHE CABINA
CAR FEATURES

Pavimento <i>Floor</i>	Linoleum P11 Grigio marmorizzato <i>P11 Marbled Grey Linoleum</i>
Pareti <i>Walls</i>	Lamiera plastificata R2 Bianco <i>R2 White plastic-coated steel sheet</i>
Pulsantiera <i>Button panel</i>	Line - lamiera plastificata R2 Bianco <i>Line - R2 White plastic-coated steel sheet</i>
Corrimano <i>Handrail</i>	Eclisse - acciaio cromato incassato su parete <i>Eclisse - chrome-coated, built into the panel</i>
Sistema di illuminazione <i>Lighting system</i>	Trama* - strisce LED <i>Trama* - LED stripes</i>
Specchio <i>Mirror</i>	Luce - a mezza parete <i>Luce - half wall mirror</i>

SISTEMI DI ILLUMINAZIONE / LIGHTING SYSTEMS



PURO

CIELINO: lamiera plastificata bianca
 ILLUMINAZIONE: faretto a LED
 CEILING: white plastic coated steel sheet
 LIGHTING: round LED Spots



TRAMA*

CIELINO: lamiera plastificata bianca
 ILLUMINAZIONE: strisce LED
 CEILING: white plastic coated steel sheet
 LIGHTING: LED stripes

PULSANTIERE / BUTTON PANEL

PULSANTIERA DI CABINA
 CAR BUTTON PANEL



LINE

Montaggio a filo,
 disponibile
 negli stessi
 materiali dei
 rivestimenti delle
 pareti
 Flush mounting,
 same wall
 materials available

PULSANTIERA DI PIANO
 FLOOR BUTTON PANEL



MINIMAL

Acciaio inox,
 1 pulsante
 Stainless steel,
 1 button



FLORENCE

Acciaio inox,
 1 pulsante
 Stainless steel,
 1 button

CORRIMANI/HANDRAILS

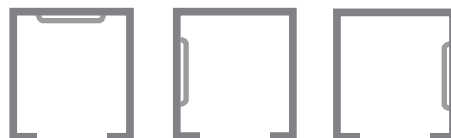

ORBITA

Corrimano in acciaio
 cromato fissato su parete
 Chrome-coated handrail, fixed
 to the panel



ECLISSE

Corrimano acciaio cromato
 incassato su parete
 Chrome-coated handrail, built
 into the panel

SPECCHI/MIRRORS

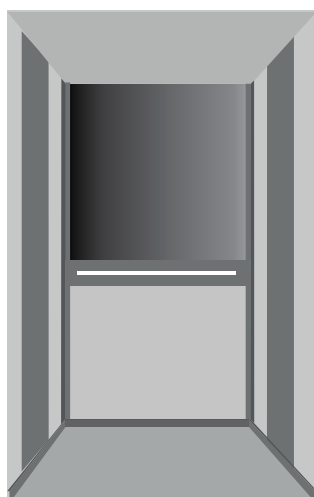

LUCE

Specchio a mezza parete
 Half wall mirror

03

COMFORT

L'ascensore sofisticato
The sophisticated elevator

La collezione Comfort, offre interni flessibili, eleganti e sofisticati che si adattano perfettamente a qualsiasi ambiente. Soluzioni ricercate ed eleganti, creano un ambiente accattivante e armonioso al tempo stesso.

The Comfort collection offers elegant and sophisticated interiors, which blend with any environment. Elegant and refined solutions create an harmonious and endearing space at the same time. This collection combines patterned coverings in stainless steel sheet, to obtain a balance between nature and technology.



COMFORT

CARATTERISTICHE CABINA
CAR FEATURES

Pavimento
Floor

Cemento G7
G7 Cement

Pareti
Walls

Acciaio scotch brite S15
S15 Scotch brite stainless steel

Specchio
Mirror

Riflesso - specchio a tutta altezza intelaiato
Riflesso - full wall mirror with protection frame

Pulsantiera, Aerazione, profili
Button panel, Ventilation, angle
profiles

Line* - acciaio inox BA lucido
Line* - glossy BA stainless steel

Sistema di illuminazione
Lighting system

Segno - strisce LED
Segno - LED stripes

RIVESTIMENTI PARETI / WALL FINISHES

LAMIERA PLASTIFICATA / PLASTIC COATED STEEL SHEET

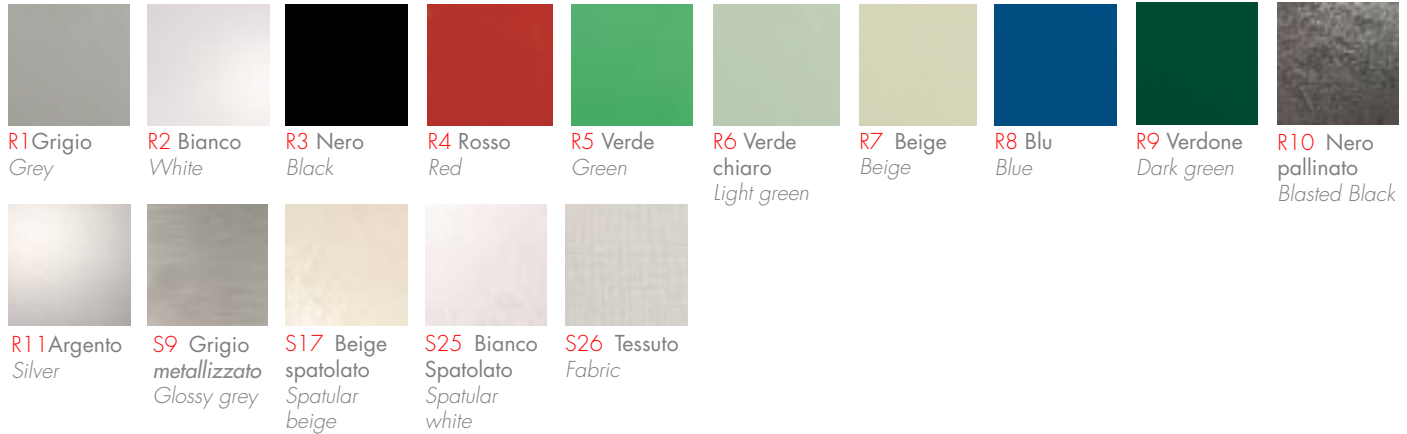

R1 Grigio
Grey

R2 Bianco
White

R3 Nero
Black

R4 Rosso
Red

R5 Verde
Green

R6 Verde
chiaro
Light green

R7 Beige
Beige

R8 Blu
Blue

R9 Verdone
Dark green

R10 Nero
pallinato
Blasted Black



R11 Argento
Silver

S9 Grigio
metallizzato
Glossy grey

S17 Beige
spatolato
Spatular
beige

S25 Bianco
Spatolato
Spatular
white

S26 Tessuto
Fabric

ACCIAIO INOX - ALLUMINIO / STAINLESS STEEL - ALUMINUM

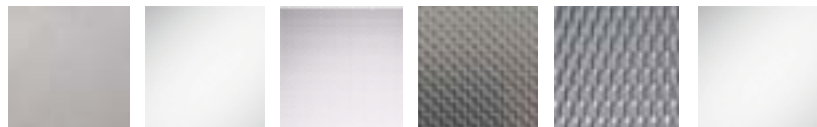

S15 Scotch
brite
Scotch brite

S16 B-A
lucido
Glossy B-A

S11 Lino
Linen

S12 Quadro
Square
pattern

S10 5wl
lucido
Glossy 5wl

S36 Alluminio
Aluminum

LAMINATO / LAMINATED



L1 Bianco
White

L2 Bianco
Sporco
Off white

L3 Grigio
Grey

L4 Pesca
Peach

L5 Marrone
Brown

L6 Blu
Blue

L7 Bianco
perlato
Pearl-white

L8 Grigio
perlato
Pearl grey

L9 Radica
Briar-root

L10 Radica
Chiara
Light briar-root

PAVIMENTI / FLOORS

PAVIMENTO VINILICO - EFFETTO LEGNO (Doga 178X1219mm) / VINYL FLOOR - WOOD ESSENCE (Slat 178X219mm)

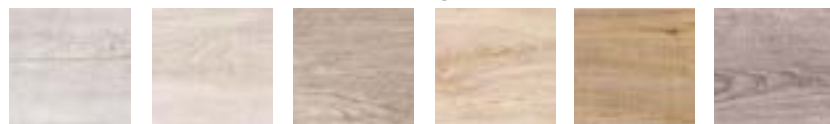

G1 Rovere
inverno
Winter
durmast

G2 Rovere
grigio cenere
Ash gray
durmast

G3 Rovere
marittimo
Maritime
durmast

G4 Rovere
dorato
Golden
durmast

G5 Rovere
naturale
Natural
durmast

G6 Rovere
cottage
Cottage
durmast

PAVIMENTO VINILICO - EFFETTO TENDENCY (Piastra 305X610 mm) / VINYL FLOOR - TENDECY EFFECT (Slat 178X219 mm)



G7 Cemento
Concrete

G8 Ramato
Copper

G9 Resina
grigia
Grey resin

G10 Beton
Beton

ACCIAIO INOX / STAINLESS STEEL

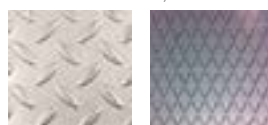

P10 Acciaio
mandorlato
Almond
shape

P11 Lamiera
striata
Checked
plated

COMFORT

CARATTERISTICHE CABINA
CAR FEATURES

Pavimento
Floor

A cura del committente
Provided by the client

Pareti
Walls

Laminato bianco L1 con strisce cromate
L1 white laminate with chrome stripes

Specchio
Mirror

Luce - specchio a mezza parete
Luce - half-wall mirror

Pulsantiera, Aerazione, profili
Button panel, Ventilation, angle
profiles

Line Colour - acciaio inox BA lucido
Line Colour - glossy B-A stainless

Corrimano
Handrail

Eclisse - inox cromato, incassato su parete
Eclisse - chrome-coated handrail, built into the panel

Sistema di illuminazione
Lighting system

Diffuso - modulo LED
Diffuso - LED module

BOTTONIERA DI CABINA / CAR BUTTON PANEL



LINE
 Montaggio a filo, display LCD, disponibile negli stessi materiali dei rivestimenti delle pareti
Flush mounting, LCD display same wall materials available



LINE COLOUR
 Montaggio a filo, display TFT, disponibile negli stessi materiali dei rivestimenti delle pareti
Flush mounting, TFT display, same wall materials available



LINE*
 Montaggio a filo, display TFT, strisce LED, disponibile negli stessi materiali dei rivestimenti delle pareti
Flush mounting, TFT display, same wall materials available



FLORENCE
 Pulsantiera di cabina in acciaio inox con display TFT
Stainless steel COP with TFT display

PULSANTIERA DI PIANO / FLOOR BUTTON PANEL

FLORENCE

Finiture: acciaio inox scotch brite, lucido, mirror, oro* e oro satinato* (su richiesta altre finiture)
Finish: scotch brite, glossy, mirror stainless steel, gold and satin gold* (other finishes on request)*



Acciaio inox,
 1 pulsante + display
Stainless steel, 1 button + display



Acciaio inox,
 2 pulsanti
Stainless steel, 2 buttons



Acciaio inox,
 1 pulsante
Stainless steel, 1 button

MINIMAL

Finiture: acciaio inox scotch brite, lucido, mirror, oro* e oro satinato* (su richiesta altre finiture)
Finish: scotch brite, glossy, mirror stainless steel, gold and satin gold* (other finishes on request)*



Acciaio inox,
 1 pulsante
Stainless steel, 1 button

BUGATTI

Finiture: scotch brite, nero*, madreperla* e lucida* (cromo e oro)
Finish: scotch brite stainless steel, black, Pearl* and mirrored (chrome and gold)**



Acciaio inox,
 1 pulsante + display
Stainless steel, 1 button + display



Acciaio inox,
 2 pulsanti
Stainless steel, 2 buttons



Acciaio inox,
 1 pulsante
Stainless steel, 1 button

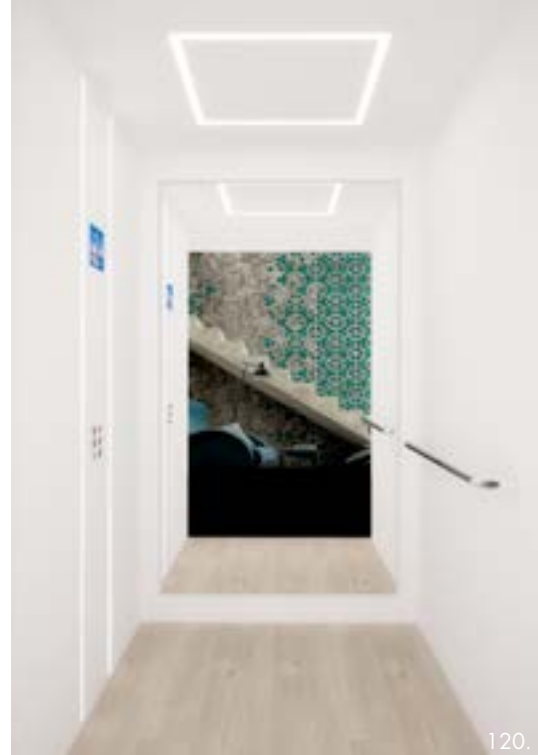

SISTEMI DI ILLUMINAZIONE / LIGHTING SYSTEMS



PURO
 CIELINO: lamiera plastificata
 bianca o acciaio inox
 ILLUMINAZIONE: faretto a LED
 CEILING: white plastic coated
 steel sheet or stainless steel
 LIGHTING: LED Spots



TRAMA
 CIELINO: lamiera plastificata
 bianca o acciaio inox
 ILLUMINAZIONE: strisce LED
 CEILING: white plastic coated
 steel sheet or stainless steel
 LIGHTING: LED stripes



SEGNO
 CIELINO: lamiera plastificata
 bianca o acciaio inox
 ILLUMINAZIONE: strisce LED
 CEILING: white plastic coated
 steel sheet or stainless steel
 LIGHTING: LED stripes



RAGGIO
 CIELINO: lamiera plastificata
 bianca o acciaio inox
 ILLUMINAZIONE: modulo LED
 CEILING: white plastic coated
 steel sheet or stainless steel
 LIGHTING: LED module

SPECCHI / MIRRORS

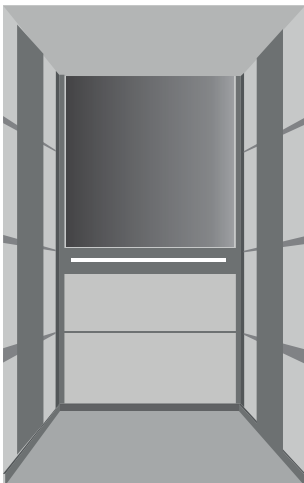

LUCE
 Specchio a mezza parete
 Half-wall Mirror

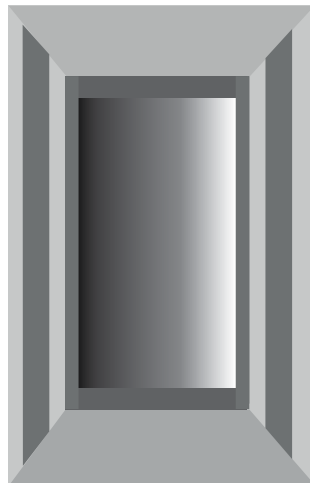

RIFLESSO
 Specchio a tutta altezza con
 cornice di protezione
 Full-wall mirror with protection
 frame

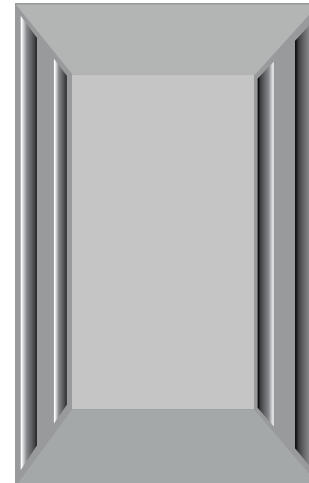

PROIEZIONE
 Specchi laterali a tutta altezza
 con cornici di protezione
 Full-wall mirrors with protection
 frames on walls side

CORRIMANI / HANDRAILS

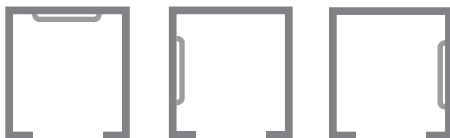

ORBITA
 Corrimano cromato fissato
 su parete
 Chrome-coated handrail,
 fixed to the panel



ECLISSE
 Corrimano cromato
 incassato su parete
 Chrome-coated handrail,
 built into the panel

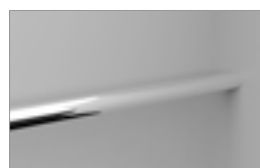

AURORA
 Corrimano alluminio o
 acciaio inox
 Aluminum or stainless steel
 handrail

04

UNIQUE

La soluzione sempre perfetta disegnata da te, per te.
Always the perfect solution designed by you for you.

La collezione Unique offre un design esclusivo e personalizzabile in grado di soddisfare qualsiasi richiesta del cliente, dalla scelta alla combinazione dei materiali e degli accessori. Un raffinato spazio polisensoriale, dove materiali pregiati e ricercate finiture offrono una coinvolgente esperienza tattile e visiva.

The Unique collection offers an exclusive, tailored and classy design, able to satisfy any request of the client, from the choice to the combination of materials and accessories.

A sophisticated multi-sensory environment, where precious materials and refined finishes offer an engaging tactile and visual experience.

30 Kg 2 Pers.

2
1
0

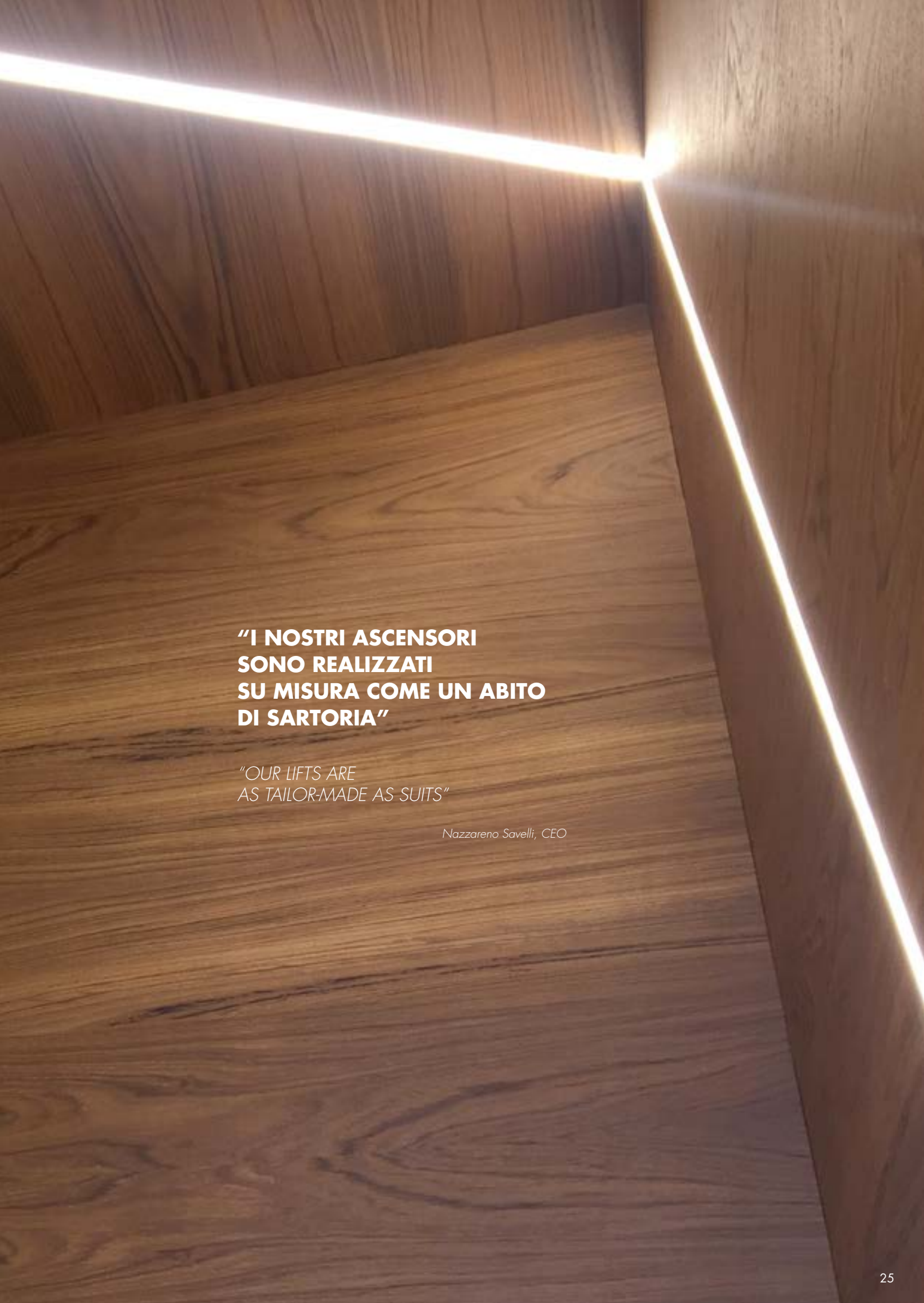

**"I NOSTRI ASCENSORI
SONO REALIZZATI
SU MISURA COME UN ABITO
DI SARTORIA"**

*"OUR LIFTS ARE
AS TAILOR-MADE AS SUITS"*

Nazzareno Savelli, CEO



UNIQUE

CARATTERISTICHE CABINA CAR FEATURES

Pavimento
Floor

Marmo fornito dal committente
Marble provided by the client

Pareti
Walls

Carta da parati a cura del committente
Wall paper provided by the client

Sistema di illuminazione
Lighting system

Puro - faretti LED
Puro- LED spots

Pulsantiera
Operating panels

Venice Touch - vetro nero specchiato
Venice Touch - black mirrored glass

RIVESTIMENTI PARETI / WALL FINISHES

ACCIAIO INOX / STAINLESS STEEL

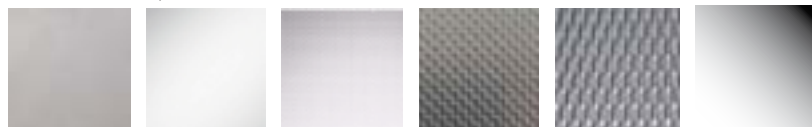

S15 Scotch brite
Scotch brite

S16 B-A lucido
Glossy B-A

S11 Lino
Linen

S12 Quadro Square
Square pattern

S10 5wl lucido
Glossy 5wl

S19 Super mirror
Super mirror



S20 Silver satinato
Glazed Silver

S21 Nero satinato
Glazed Black

S22 Oro satinato
Glazed gold

S23 Blu satinato
Glazed Blue

S24 Fucsia satinato
Glazed violet



S13 Rame a specchio
Mirror Copper

S18 Bronzo
Bronze

S14 Oro
Gold

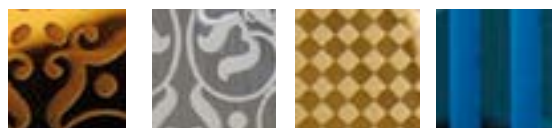

S31 Flor bronzo
Flor bronze

S32 Flor silver
Flor Silver

S33 Quadri oro
Gold squares

S34 Blu rigato
Striped blue

ALLUMINIO / ALUMINUM



VETRO COLORATO O DECORATO / COLOURED GLASS



CARTA DA PARATI O STAMPA DIGITALE / WALLPAPER OR DIGITAL PRINT

Crea un'atmosfera speciale non solo con i colori, ma anche con forme geometriche o organiche di tuo gusto. Qualunque sia la dimensione della tua cabina, la carta da parati o la decorazione digitale avrà sempre un effetto sorprendente

Create a special atmosphere not only with colors, but also with geometric or organic shapes of your taste. Regardless of the size of your cabin, the wallpaper or digital decoration will always have an amazing effect.



MARMO / MARBLE

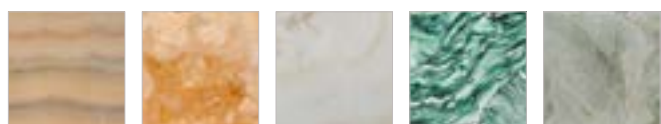

M1 Tigrato
Tigerskin

M2 Miele
Honey

M3 Avorio
Ivory

M4 Kryptonite
Kryptonite

M5 Verde persiano
Persian green

CORIAN



C1 Bianco
White

C2 Grigio
Grey

C3 Marrone
Brown

UNIQUE

CARATTERISTICHE CABINA A DOPPIO ACCESSO DIAGONALE
CAR FEATURES

Pavimento <i>Floor</i>	Marmo fornito dal committente <i>Marble provided by the client</i>
Parete 1 <i>Walls 1</i>	Acciaio inox oro S14 <i>S14 Gold stainless steel</i>
Pulsantiera, Aerazione <i>Button panel, Ventilation</i>	Line - Acciaio inox oro S14 <i>Line - S14 Gold stainless steel</i>
Parete 2 <i>Walls 2</i>	Carta da parati a cura del committente <i>Wall paper provided by the client</i>
Sistema di illuminazione <i>Lighting system</i>	Puro - faretti LED <i>Puro - LED spots</i>

PAVIMENTI / FLOORS

PAVIMENTO VINILICO - EFFETTO LEGNO (Doga 178X1219mm) / VINYL FLOOR - WOOD ESSENCE (Slat 178X219mm)

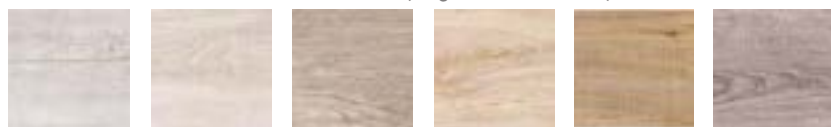

- G1** Rovere invernò
Winter durmast
- G2** Rovere grigio cenere
Ash gray durmast
- G3** Rovere marittimo
Maritime durmast
- G4** Rovere dorato
Golden durmast
- G5** Rovere naturale
Natural durmast
- G6** Rovere cottage
Cottage durmast

PAVIMENTO VINILICO - EFFETTO TENDENCY (Piastra 305X610 mm) / VINYL FLOOR - TENDENCY EFFECT (Slat 178X219)

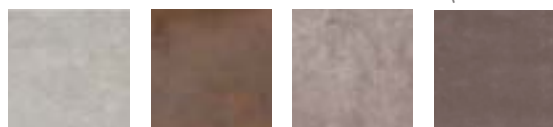

- G7** Cemento
Concrete
- G8** Ramato
Copper
- G9** Resina grigia
Grey resin
- G10** Beton
Beton

ACCIAIO INOX / STAINLESS STEEL

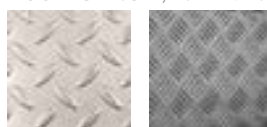

- P10** Acciaio mandorlato
Almond shape
- P11** Lamiera striata
Streaked plate

MARMO / MARBLE



- M1** Tigrato
Tigerskin
- M2** Miele
Honey
- M3** Avorio
Ivory
- M4** Kryptonite
Kryptonite
- M5** Verde persiano
Persian green

SISTEMI DI ILLUMINAZIONE / LIGHTING SYSTEMS

NOTA: su richiesta è possibile realizzare cielini differenti / On request, it is possible to create different ceilings.



PURO
CIELINO: lamiera plastificata bianca o acciaio inox
ILLUMINAZIONE: faretto a LED
CEILING: white plastic coated steel sheet or stainless steel
LIGHTING: LED Spots



TRAMA
CIELINO: lamiera plastificata bianca o acciaio inox
ILLUMINAZIONE: strisce LED
CEILING: white plastic coated steel sheet or stainless steel
LIGHTING: LED stripes



SEGNO
CIELINO: lamiera plastificata bianca o acciaio inox
ILLUMINAZIONE: strisce LED
CEILING: white plastic coated steel sheet or stainless steel
LIGHTING: LED stripes



QUADRO
CIELINO: lamiera plastificata bianca o acciaio inox
ILLUMINAZIONE: modulo LED
CEILING: white plastic coated steel sheet or stainless steel
LIGHTING: LED module



DIFFUSO
CIELINO: lamiera plastificata bianca o acciaio inox
ILLUMINAZIONE: modulo LED
CEILING: white plastic coated steel sheet or stainless steel
LIGHTING: LED module



RAGGIO
CIELINO: lamiera plastificata bianca o acciaio inox
ILLUMINAZIONE: strisce LED
CEILING: white plastic coated steel sheet or stainless steel
LIGHTING: LED stripes

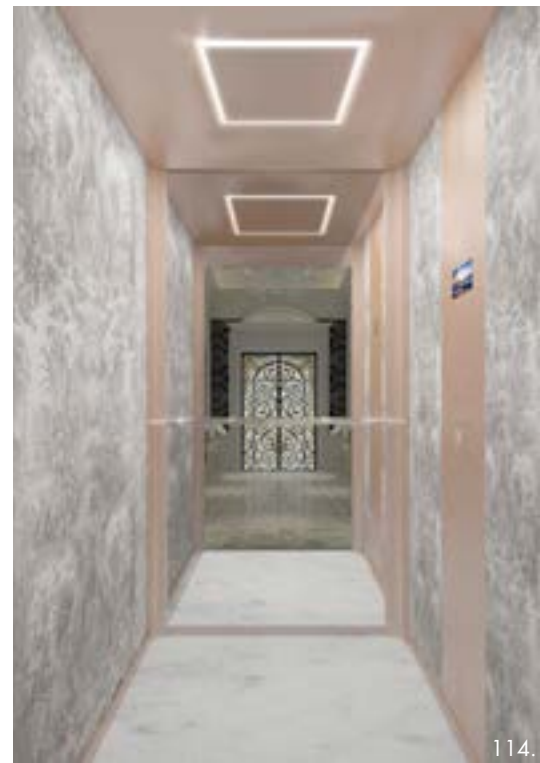



UNIQUE

CARATTERISTICHE CABINA CAR FEATURES

Pareti
Walls

Rivestite con pannelli decorati a mano
Covered with panels decorated by hands

Porte di cabina
Car doors

Rivestite con pannelli decorati a mano
Covered with panels decorated by hands

Pulsantiera
Button panel

Line Colour - display TFT 7"
Line Colour - TFT 7" display

Sistema di illuminazione
lighting system

Zeta - strisce LED
Zeta - LED stripes

BOTTONIERE / OPERATING PANELS

VENICE TOUCH

Finiture: vetro specchiato nero o bianco
 Finishes: black or white mirrored glass



1. Colonna
Column
2. Piastra di piano con freccia
Landing panel with arrows
3. Piastra di piano con TFT e freccia
Landing panel with TFT indicator and arrows

ITALIA SOFT



1. Pulsantiera di cabina piana, in acciaio inox e vetro
Faceplate Lop in stainless steel and glass
2. Pulsantiera di piano piana in acciaio inox scotch brite con display + 1 pulsante
Faceplate Cop in Scotch brite with a display and 1 button

NEW BRICK TOUCH

vince il Good Design Award 2015
 Has won the Good Design Award 2015



1. Colonna in Corian® Dupont TM, ergonomica, traslucente e con tecnologia touch
Ergonomic, traslucet Corian® DupontTM column with touch technology
2. LOP con display e 1 o 2 pulsanti
LOP with display and 1 or 2 push buttons

NEW MARBLE TOUCH



1. Colonna in marmo, con tecnologia touch
Marble column with touch technology
2. LOP con display e 1 o 2 pulsanti
LOP with display and 1 or 2 push buttons

FLORENCE

Finiture: scotch brite, inox lucido, oro satinato* e oro lucido*
 Finishes: scotch brite, glossy inox, satin gold and mirror gold



Pulsantiera di cabina in acciaio inox con display TFT
 Stainless steel COP with TFT display



Pulsantiera di cabina in acciaio inox con particolare forma TFT
 Stainless steel COP with special TFT display

FLORENCE



Bottoniera di piano in acciaio inox, 1 pulsante + display
 Stainless steel LOP, 1 button + display



Bottoniera di piano in acciaio inox, 2 pulsanti
 Stainless steel LOP, 2 button + display



Bottoniera di piano in acciaio inox, 1 pulsanti
 Stainless steel LOP, 1 button

LINE COLOUR

Finitura: disponibile nello stesso materiale delle pareti della cabina
 Finish: same car wall materials available



Colonna a filo e ad altezza cabina con display TFT
 Full height cabin column and flush mounting with TFT display

LINE+



Pulsantiera di cabina a filo disponibile nelle stesse finiture della cabina, con display TFT + strisce LED
 Full height cabin column with TFT display and LED stripes available in the same wall materials

BUGATTI - BOTTONIERA DI PIANO / BUGATTI

Finiture: scotch brite, nero*, madreperla*, lucida* (cromo e oro), oro lucida* e oro satinato*
 Finishes: scotch brite stainless steel, black*, Pearl * and mirrored [chrome and gold]*



Acciaio inox, 1 pulsante + display
 Stainless steel, 1 button + display



Acciaio inox, 2 pulsanti
 Stainless steel, 1 button + display



Acciaio inox, 2 pulsanti
 Stainless steel, 1 button + display

MINIMAL

Finiture: acciaio inox scotch brite, lucido, mirror, oro* e oro satinato* (su richiesta altre finiture)
 Finishes: scotch brite, glossy inox, satin gold* and mirror gold* (on request other finishes)



Acciaio inox, 1 pulsante
 Stainless steel, 1 button





**LA SOLUZIONE SEMPRE
PERFETTA DISEGNATA
DA TE, PER TE**
*YOU ALWAYS DESIGN THE PERFECT
SOLUTION FOR YOU*

Cabina in acciaio super mirror e stampa digitale
personalizzata
Super mirror steel car with customized digital print

SPECCHIO / MIRROR

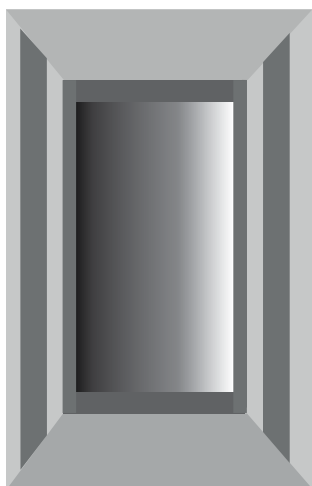

RIFLESSO
Specchio a tutta altezza intelaiato
Full-wall mirror with protection frame

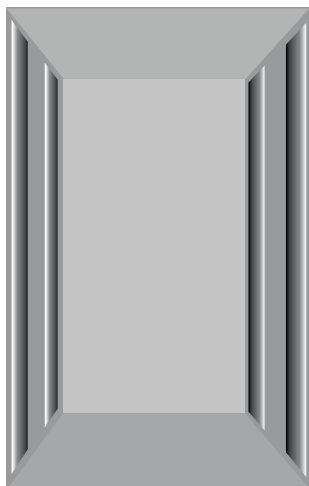

PROIEZIONE
Specchi laterali a tutta altezza
Full-wall mirrors with protection frames on wall sides

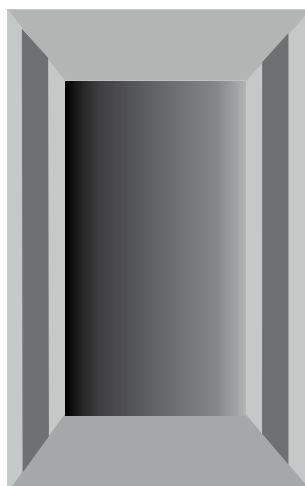

STRASCICO
Specchio a tutta altezza
Full-wall mirror

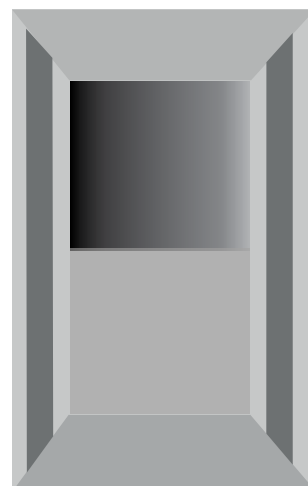

OMBRA
Specchio a metà altezza
Half-wall mirror

CORRIMANO / HANDRAIL



ORBITA
Corrimano cromato fissato su parete
Chrome-coated handrail, fixed to the panel



ECLISSE
Corrimano cromato incassato su parete
Chrome-coated handrail, built into the panel



AURORA
Corrimano acciaio inox
Stainless steel handrail



UNIQUE

CARATTERISTICHE CABINA
CAR FEATURES

Pavimento
Floor

Marble
Marble

Pareti
Walls

Boiserie bianca
White boiserie

Pulsantiera, Aerazione,
Button panel, Ventilation, angle
profiles

Acciaio inox mirror e swarovski
Mirror stainless steel and swarovski

Cielino
Ceiling

Segno - strisce LED
Segno - LED stripes

Porte
Doors

Acciaio inox super mirror
Super mirror stainless steel

PORTE

DOORS

Un look impeccabile in ogni dettaglio
An impeccably detailed look



PORTE DI PIANO - FLOOR DOORS

PORTA AUTOMATICA SENZA RIQUADRATURA

Automatic door without squaring frame

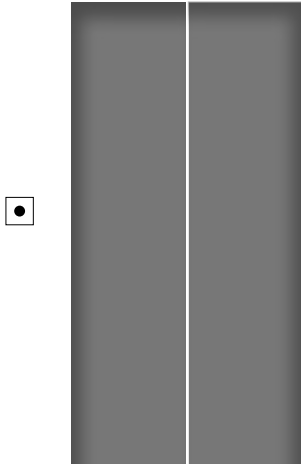

PORTA AUTOMATICA CON RIQUADRATURA IN MARMO O LEGNO

Automatic door with marble or wood squaring frame provided by the client

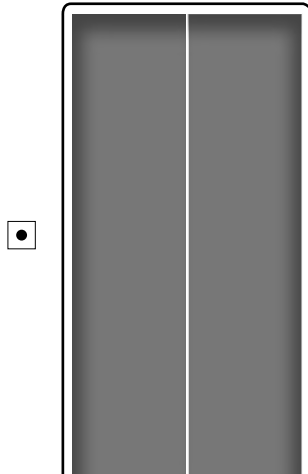

PORTA AUTOMATICA CON RIQUADRATURA

Automatic door with squaring frame

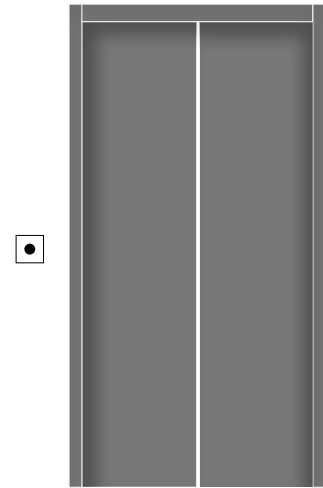

PORTA AUTOMATICA CON TELAIO

Automatic door with frame

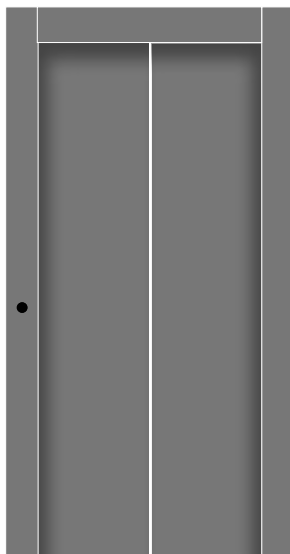

PORTA AUTOMATICA IN VETRO INTELAIATO

Automatic glass door with frame

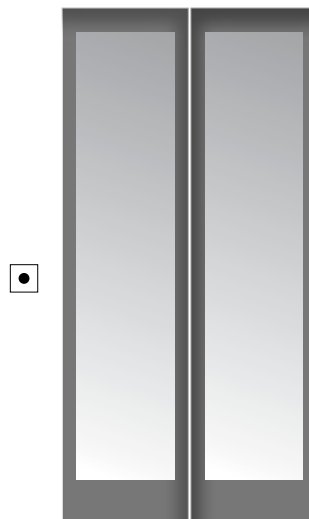

PORTA AUTOMATICA IN VETRO PORTANTE

Automatic glass door

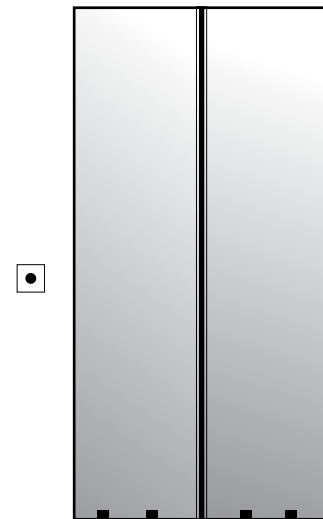

PORTA DI PIANO A SOFFIETTO

Automatic folding door

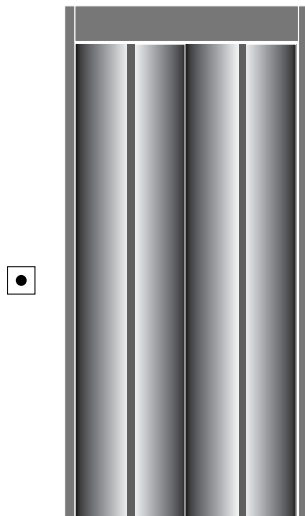

PORTA A BATTENTE IN LAMIERA VERNICIATA

Painted sheet swing door

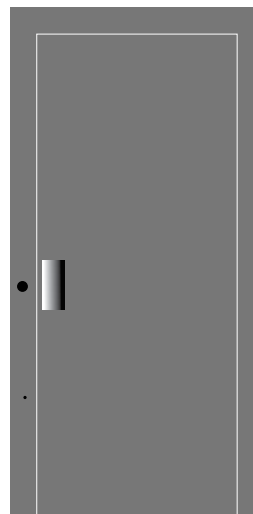

PORTA A BATTENTE IN ALLUMINIO E VETRO

Aluminum and glass swing door

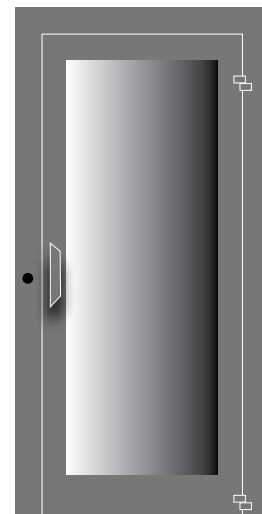



PORTA DI PIANO VERNICIATA RAL / RAL painted floor door



**PORTA DI PIANO
IN LAMIERA PLASTIFICATA S9 GRIGIO METALLIZZATO**
S9 Glossy grey plastic coated steel sheet floor door



**PORTA DI PIANO
E DI CABINA IN ACCIAIO ORO**
Gold stainless steel doors



PORTA DI PIANO E DI CABINA IN VETRO PORTANTE
Glass doors



Infiniti modi di personalizzare i tuoi display grazie alla nuova gamma di TFT.

You can always customize your TFT with all kind of picture

DISPLAY LCD / LCD DISPLAY



TRICOLOR

1. Display LCD di cabina
LCD car indicator
2. Display LCD di piano
LCD landing indicator

FUNZIONI PRINCIPALI

- Schermo: in policarbonato trasparente antiurto e antigraffio
- Freccia salita discesa

MAIN FEATURES

- LCD model: car indicator LCD available in blue or background
- Screen: lens polycarbonate (shock-proof and anti crash)
- Up and down arrow

DISPLAY TFT / TFT DISPLAY



IRIS EXCELLENCE

1. Display alta risoluzione per cabina, linea excellence
Excellence line, high resolution car indicator
2. Display TFT di piano
TFT landing position indicator

FUNZIONI PRINCIPALI

- Completamente personalizzabile (sfondo, frecce, piani, logo e segnali).
- Sintesi vocale integrata
- Gestione immagini alta risoluzione
- Riproduzione musica e audio ad alta qualità
- Riproduzione video alta risoluzione
- Orologio analogico e digitale
- USB Host connectivity
- Aggiornamento tramite SD Card
- Connettività LAN
- Uscita video: HDMI

MAIN FEATURES

- Customizable background, arrows, floor, logo and signs
- Voice synthesizer integrated
- HD Images management
- High quality Music and audio player
- HD Video player
- Analog and digital clock
- USB HOST connectivity
- SD Card updating
- LAN connection
- HDMI video output

IRIS 7"
154.1 X 86 mm

IRIS 10.1" 222.72 X

IRIS 15.6" 344.2 X

Area visibile / Visible Area



IRIS 21.5"
476.64 X 268.11 mm

IRIS 18.5"
409.8 X 230.4 mm

IRIS 15.6"
344.2 X 193.5 mm

Area visibile / Visible Area

IRIS TOUCH

Display touch alta risoluzione.
HD touch display

FUNZIONI PRINCIPALI

- Completamente touch con sfondi, frecce, loghi e segnalazioni personalizzabili
- Risoluzione Full HD
- Possibilità di aggiornare video o musica
- Sintesi vocale integrato
- Orologio integrato

MAIN FEATURES

- Completely touch with customizable background, arrows, floors, logo and signs
- Full HD resolution
- Updatable music and video
- Voice synthesizer
- Integrated clock

CONTATTO A CHIAVE CIRCOLARE / ILLUMINATED EMERGENCY LIGHT



Contatto a chiave luminoso per abilitare l'utilizzo dell'ascensore solo a persone autorizzate, in condomini o ambienti professionali in cui è richiesto un particolare controllo sull'accesso

Illuminated emergency light to enable the use of the lift by authorized people only, where an access control is required.

CHIAVE ELETTRONICA / ELECTRONIC KEY



I-BUTTON EVO

Chiave elettronica antivandalo per il controllo degli accessi in ascensore

Electronic key to check accesses in lift.



RFID

Letto di prossimità per il controllo degli accessi in ascensore. Funzionante con BADGE /TAGS di prossimità

Proximity reader to check accesses in lift. It works with TAGS and proximity cards.



STICKERS

Etichette adesiva di prossimità per il controllo degli accessi in ascensore

Sticky proximity cards to check accesses in lift

LETTORE E CONTROLLER IN UN UNICO PRODOTTO / READER AND CONTROLLER IN A ONLY PRODUCT



C-RFID EM IP

È un controller per la limitazione dell'uso di un ascensore con lettore integrato di chiavi elettroniche.

This controller limits the lift use through integrated reader of electronic keys



C-CODE EM

È un dispositivo per il comando locale dell'automazione attraverso un codice numerico

This device control the automation locally through a numerical code



C-BIOMETRIC

È un controller per la limitazione dell'uso di un impianto ascensoristico, con lettore integrato di impronte digitali e di chiavi elettroniche

This controller limits the lift use through integrated reader of fingerprints and electronic keys



C-BLUETOOTH

È un controller per la limitazione dell'uso di un impianto ascensoristico, con ricevitore bluetooth integrato. Lo smartphone sarà il proprio strumento d'identificazione personale

This controller limits the lift use through integrated bluetooth receiver. Your smartphone will be your identification tool



ACCESSO SINGOLO / SINGLE ACCESS

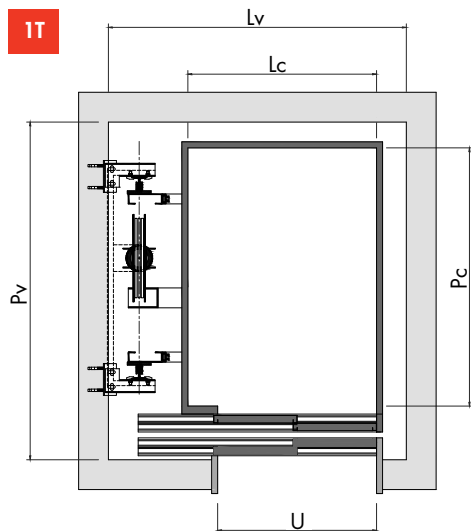

PORTE AUTOMATICHE TELESCOPICHE / AUTOMATIC TELESCOPIC DOORS

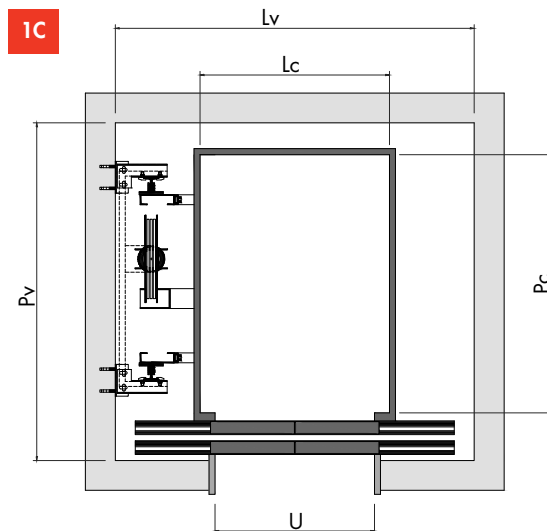

PORTE AUTOMATICHE CENTRALI / AUTOMATIC CENTRAL DOORS

DOPPIO ACCESSO FRONTALE / FRONTAL DOUBLE ACCESS

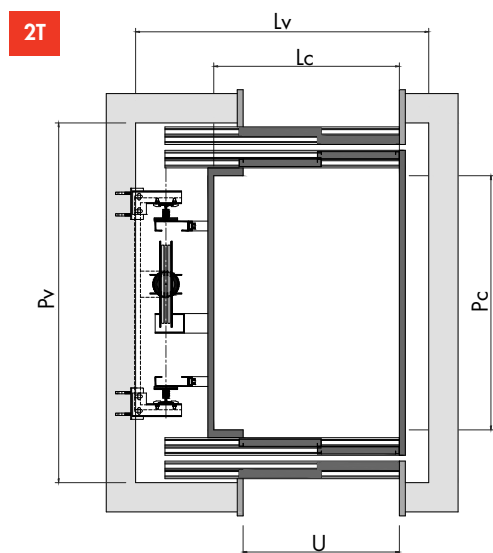

PORTE AUTOMATICHE TELESCOPICHE / AUTOMATIC TELESCOPIC DOORS

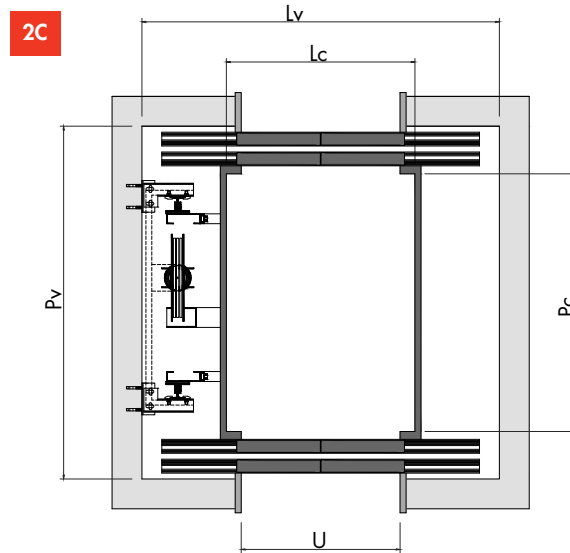

PORTE AUTOMATICHE CENTRALI / AUTOMATIC CENTRAL DOORS

DOPPIO ACCESSO DIAGONALE / FRONTAL DOUBLE ACCESS

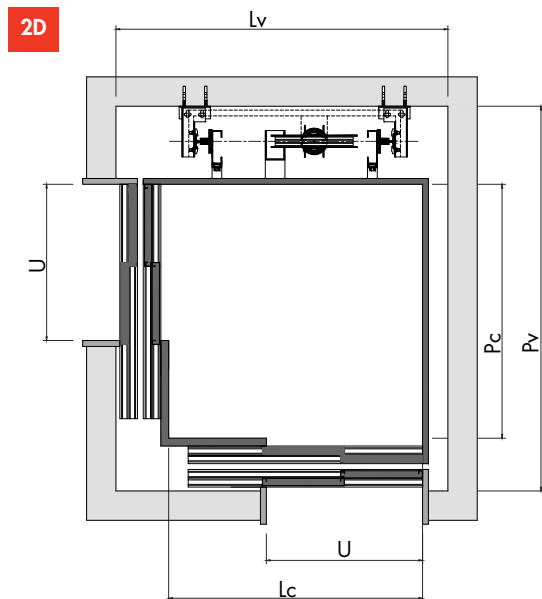

PORTE AUTOMATICHE TELESCOPICHE / AUTOMATIC TELESCOPIC DOORS

NOTA:
 le quote riportate nelle tabelle rispettano le normative italiane L13/89 e DM 236/89 e comunitarie 81-20/50 e 81-70. Per qualunque altra esigenza rivolgersi ai nostri uffici, saremo lieti di soddisfare qualsiasi vostra richiesta

NOTE:
 The sizes in the charts comply with the Italian law L13/89 and DM 236/89, EU law 81-20/50 and 81-70. Do not hesitate to contact our office for further information. We are certainly pleased to meet your requirements.

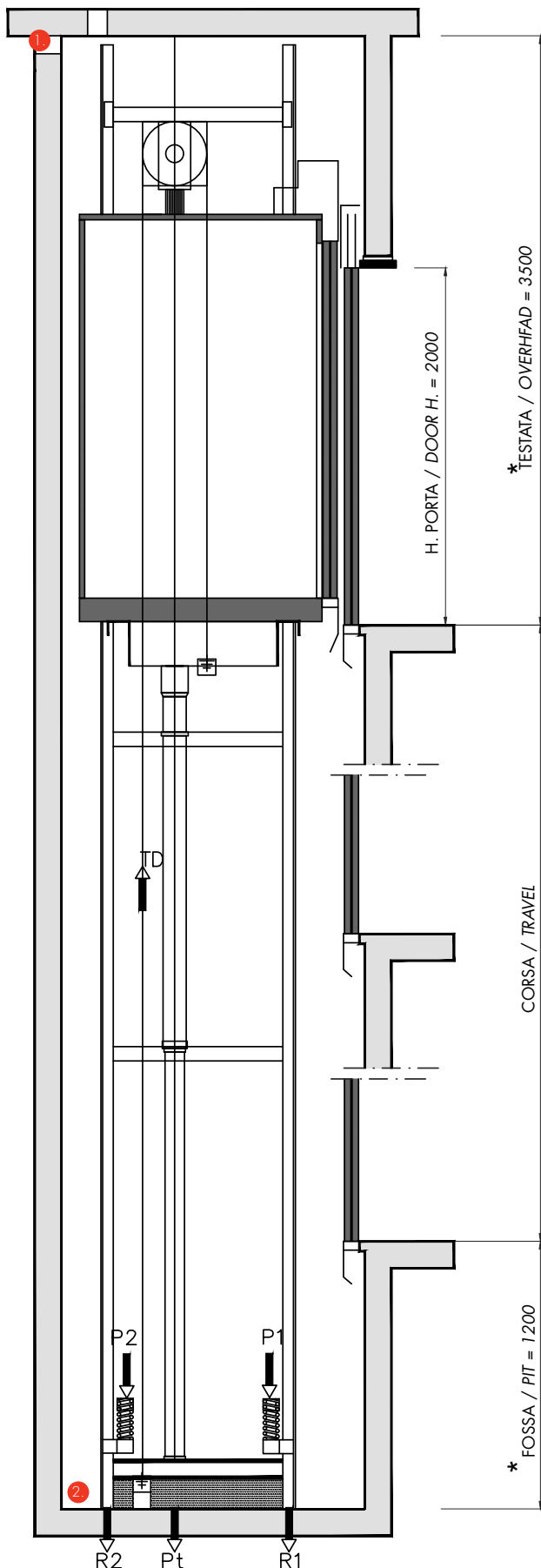

EDIFICI RESIDENZIALI DI NUOVA COSTRUZIONE / NEW RESIDENTIAL

Impianto Installation	Portata Kg Load Kg	Persone People	Dimensione cabina (mm) Car Sizes (mm)		Porte (mm) Doors (mm)	Dimensioni Vano Shaft sizes (mm)	
			Lc	Pc	U	Lv	Pv
1T	480	6	950	1300	800	1500	1700
1C	480	6	950	1300	800	1700	1600
2T	480	6	950	1300	800	1500	1780
2C	480	6	950	1300	800	1700	1680
2D*	700	9	1300	1300	800	1950	1700

*Per ascensore Gearless prevedere larghezza utile vano > 50 mm
*For Gearless elevator plan a shaft width > 50 mm

LE DIMENSIONI DELLA FOSSA E DELLA TESTATA POTREBBERO VARIARE A SECONDA DEL TIPO DI IMPIANTO. PER ULTERIORI INFORMAZIONI CONTATTARE IL NOSTRO UFFICIO TECNICO.

*PIT AND OVERHEAD DIMENSIONS MAY CHANGE ACCORDING TO THE TYPE OF ELEVATOR.

EDIFICI RESIDENZIALI PREESISTENTI / PREEXISTING RESIDENTIAL

Impianto Installation	Portata Kg Load Kg	Persone People	Dimensione cabina (mm) Car Sizes (mm)		Porte (mm) Doors (mm)	Dimensioni Vano Shaft sizes (mm)	
			Lc	Pc	U	Lv	Pv
1T	400	5	850	1200	750	1300	1550
1C	400	5	850	1200	750	1600	1500
2T	400	5	850	1200	750	1300	1680
2C	400	5	850	1200	750	1600	1580
2D*	600	7	1200	1200	750	1800	1600

Per ascensore Gearless prevedere larghezza utile vano > 50 mm
For Gearless elevator plan a shaft width > 50 mm

LE DIMENSIONI DELLA FOSSA E DELLA TESTATA POTREBBERO VARIARE A SECONDA DEL TIPO DI IMPIANTO. PER ULTERIORI INFORMAZIONI CONTATTARE IL NOSTRO UFFICIO TECNICO.

*PIT AND OVERHEAD DIMENSIONS MAY CHANGE ACCORDING TO THE TYPE OF ELEVATOR.

EDIFICI NON RESIDENZIALI / NON-RESIDENTIAL BUILDING

Impianto Installation	Portata Kg Load Kg	Persone People	Dimensione cabina (mm) Car Sizes (mm)		Porte (mm) Doors (mm)	Dimensioni Vano Shaft sizes (mm)	
			Lc	Pc	U	Lv	Pv
1T	630	8	1100	1400	900	1600	1800
1C	630	8	1100	1400	900	1900	1700
2T	630	8	1100	1400	900	1600	1880
2C	630	8	1100	1400	900	1900	1780
2D*	800	10	1400	1400	900	2150	1800

*Per ascensore Gearless prevedere larghezza utile vano > 50 mm
*For Gearless elevator plan a shaft width > 50 mm

LE DIMENSIONI DELLA FOSSA E DELLA TESTATA POTREBBERO VARIARE A SECONDA DEL TIPO DI IMPIANTO. PER ULTERIORI INFORMAZIONI CONTATTARE IL NOSTRO UFFICIO TECNICO.

*PIT AND OVERHEAD DIMENSIONS MAY CHANGE ACCORDING TO THE TYPE OF ELEVATOR.

1. Alla sommità del vano corsa prevedere apertura per aerazione regolamentare pari al 1% della superficie in pianta da portare verso l'esterno dell'edificio. Per impianti con prescrizione incendi, prevedere tale apertura pari al 3% della superficie in pianta del vano con un minimo di 0,20 mq.
At the top of the shaft, plan a regulatory ventilation opening equal to 1% of the surface to bring outside the building; For fire elevator plan this opening equal to 3% of the shaft surface with a minimum of 0,20 mq.
2. Prevedere perfetta impermeabilizzazione della fossa all'interno del vano.
Provide perfect waterproofing of the pit.

ARMADIO ASCENSORE STANDARD FINO A PORTATA 630 KG
 STANDARD ELEVATOR CABINET UP TO 630 KG

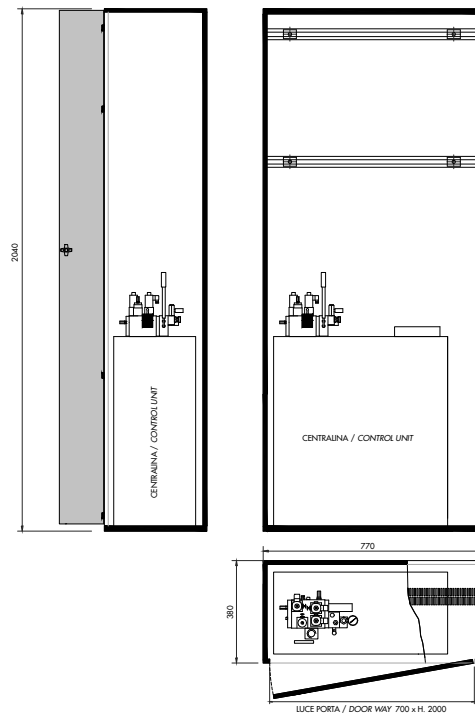

IL LOCALE DOVE VERRÀ INSTALLATO L'ARMADIO DOVRÀ ESSERE CONVENIENTEMENTE VENTILATO.
 THE CABINET MUST BE INSTALLED IN A PROPERLY AIRED PLACE

ARMADIO ASCENSORE GEARLESS SU STIPITE / CABINET ON JAMB
 FOR GEARLESS ELEVATOR

ARMADIO ASCENSORE GEARLESS STANDARD / STANDARD
 CABINET FOR GEARLESS ELEVATOR

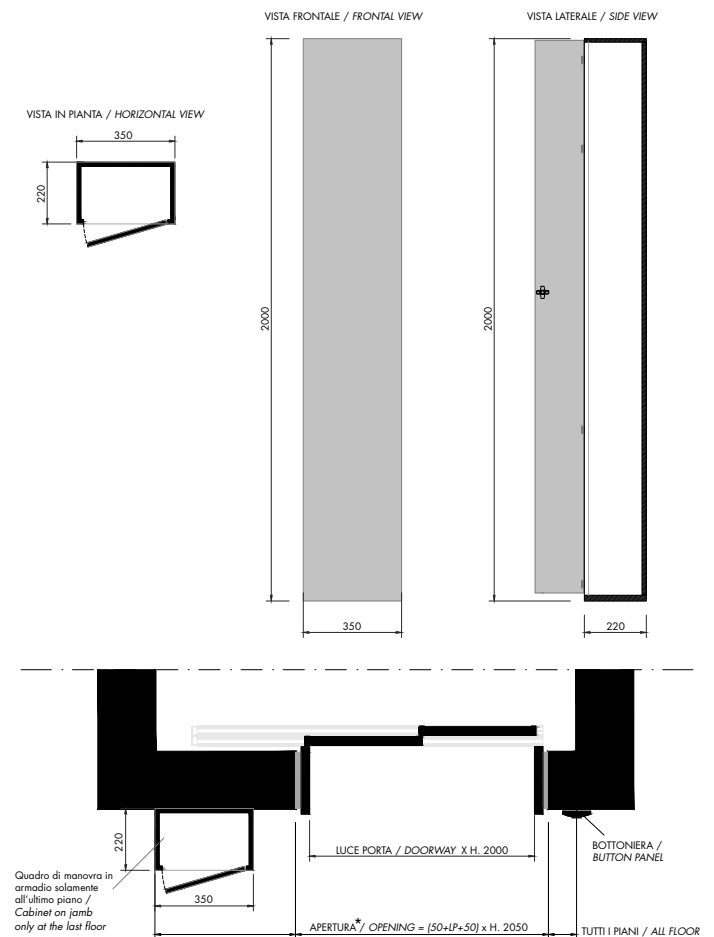
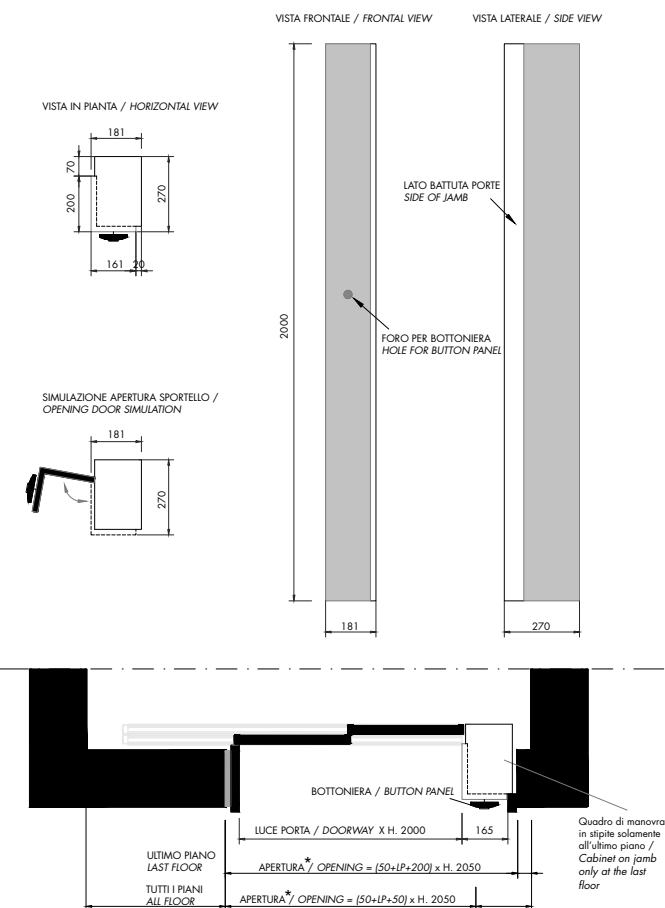

*muratura da prevedere nel caso di riquadratura porta in marmo; rivolgersi ai nostri uffici per altre tipologie di riquadrature - masonry to be provided in case of a marble door frame; contact our offices for other types of frames

SAVELLI ASCENSORI SRL

Contrada Storno, 13B/C - 63900 Fermo
Tel : +39.0734.228982 P. Iva 01865710444
savelli@savelliascensori.it

Follow us on



www.savelliascensori.it

La presente pubblicazione è a solo scopo informativo e ci riserviamo il diritto di modificare i contenuti in qualunque momento. Nessuna dichiarazione contenuta in questa brochure deve essere ritenuta garanzia o condizione, esplicita od implicita, relativamente a qualsiasi prodotto, della sua idoneità per scopi particolari, della sua commerciabilità, qualità o interpretazione dei termini di qualsivoglia contratto d'acquisto.

Potrebbero esserci piccole differenze tra i colori stampati e quelli reali.

This publication is only an informative document.

Savelli Ascensori reserves the right to modify the content at any time

There could be differences between the printed colors and those real.

Tutti i diritti riservati. All rights reserved.